

TM-P20

Technical Reference Guide

Product Overview

Describes features of the Product.

Setup

Describes setup and installation of the product.

Advanced Usage

Describes advanced usage methods for the product.

Application Development Information

Describes how to control the printer and necessary information when you develop applications.

Handling

Describes how to handle the product.

Appendix

Describes general specifications and character code tables.

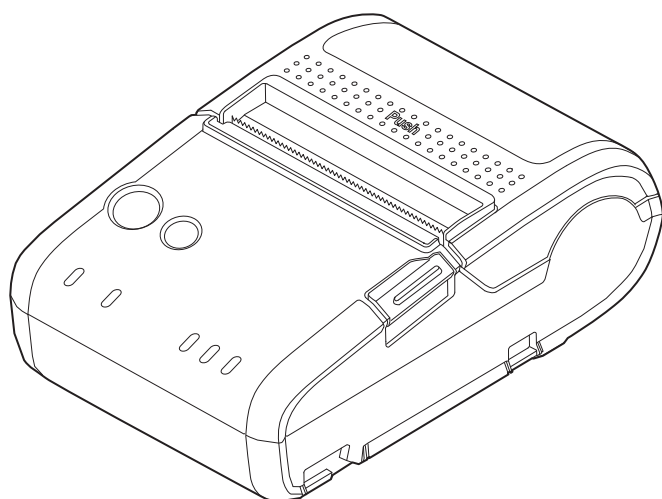

Cautions

- No part of this document may be reproduced, stored in a retrieval system, or transmitted in any form or by any means, electronic, mechanical, photocopying, recording, or otherwise, without the prior written permission of Seiko Epson Corporation.
- The contents of this document are subject to change without notice. Please contact us for the latest information.
- While every precaution has been taken in the preparation of this document, Seiko Epson Corporation assumes no responsibility for errors or omissions.
- Neither is any liability assumed for damages resulting from the use of the information contained herein.
- Neither Seiko Epson Corporation nor its affiliates shall be liable to the purchaser of this product or third parties for damages, losses, costs, or expenses incurred by the purchaser or third parties as a result of: accident, misuse, or abuse of this product or unauthorized modifications, repairs, or alterations to this product, or (excluding the U.S.) failure to strictly comply with Seiko Epson Corporation's operating and maintenance instructions.
- Seiko Epson Corporation shall not be liable against any damages or problems arising from the use of any options or any consumable products other than those designated as Original Epson Products or Epson Approved Products by Seiko Epson Corporation.

Trademarks

EPSON is a registered trademark of Seiko Epson Corporation.

Exceed Your Vision is a registered trademark or trademark of Seiko Epson Corporation.

Microsoft[®], Windows[®], and Windows Vista[®] are registered trademarks of Microsoft Corporation in the United States and/or other countries.

Wi-Fi[®], WPA[™], and WPA2[™] are either registered trademarks or trademarks of Wi-Fi Alliance[®].

The Bluetooth[®] word mark and logos are registered trademarks owned by Bluetooth SIG, Inc. and any use of such marks by Seiko Epson Corporation is under license.

IOS is a trademark or registered trademark of Cisco in the U.S. and other countries and is used under license.

Apple, Apple TV, Apple Watch, iPad, iPad Air, iPad Pro, iPhone, and Lightning are trademarks of Apple Inc., registered in the U.S. and other countries. tvOS is a trademark of Apple Inc.

QR Code is a registered trademark of DENSO WAVE INCORPORATED in Japan and in other countries.

Android[™] is a trademark of Google LLC.

Google Play and the Google Play logo are trademarks of Google LLC.

All other trademarks are the property of their respective owners and used for identification purpose only.

ESC/POS[®] Command System

Epson ESC/POS is a proprietary POS printer command system that includes patented or patent-pending commands. ESC/POS is compatible with most Epson POS printers and displays.



ESC/POS is designed to reduce the processing load on the host computer in POS environments. It comprises a set of highly functional and efficient commands and also offers the flexibility to easily make future upgrades.

©Seiko Epson Corporation 2014-2018. All rights reserved.

For Safety

Key to Symbols

The symbols in this manual are identified by their level of importance, as defined below. Read the following carefully before handling the product.

 DANGER	You must follow warnings carefully to avoid serious injury or death.
 WARNING	You must follow warnings carefully to avoid serious bodily injury.
 CAUTION	Provides information that must be observed to prevent damage to the equipment or loss of data. <ul style="list-style-type: none">• Possibility of sustaining physical injuries.• Possibility of causing physical damage.• Possibility of causing information loss.
CAUTION	Provides information that must be observed to avoid damage to your equipment or a malfunction.
NOTE	Provides important information and useful tips.

Cautions on Handling the Printer



DANGER

Do not use or charge this product in high temperature places (60°C {140°F} or higher). Furthermore, do not leave or store this product in places that are 60°C {140°F} or higher. Doing so could lead to heat, smoke, ruptures, fire, or leaks.



WARNING

- Do not use this product in a location with volatile substances such as alcohol or paint thinner, or near fire. Doing so may cause electric shock or fire.
- Shut down the product immediately if it produces smoke, a strange odor, or unusual noise. Continued use may cause electric shock or fire. When a fault or other problem occurs, immediately shut down the product and remove the battery from the product. Then, contact qualified service personnel.
- Shut down the product immediately if water or other liquid spills into this product. Continued use may cause electric shock or fire. Immediately shut down and remove the battery from the product, and contact qualified service personnel.
- Do not disassemble the areas other than those mentioned in this manual.
- Never repair this product. Tampering with this product may result in injury or fire.
- Do not use this product in an environment where flammable gas or explosive gas may exist. Do not use aerosol sprayers containing flammable gas inside or around this product. Doing so may cause fire.
- Do not connect cables in ways other than those mentioned in this manual. Doing so may cause fire. It may also damage other devices.
- Do not touch the areas inside the product other than those mentioned in this manual. Doing so may cause electric shock or burns.
- Do not insert metal or flammable materials, or allow them to fall into the product. Doing so may cause electric shock or fire.



CAUTION

- Do not allow anyone to stand or place heavy objects on top of this product. Equipment may fall or collapse, causing breakage and possible injury.
- Be sure to use within the limits of the environmental temperature conditions.

Cautions on Installation of the Printer



CAUTION

- Do not store/leave the product in an unstable location or in a location subject to vibration from other devices. Doing so may cause injury. Also, it may cause malfunction of the printer.
- Do not install the product in a location exposed to oily smoke or dust, or in a humid location. Doing so may cause electric shock or fire.
- Install the cables and optional products in the proper direction according to the proper procedures. Failure to install correctly may cause fire or injury. Follow the instructions in this manual to install them properly.

Cautions on Handling the Single Charger



WARNING

- Do not charge any device other than the TM-P20 printer or the OT-BY20 battery. Doing so may cause heat, explosion, fire, leaks, or other damage.
- Do not use this product in a location with volatile substances such as alcohol or paint thinner, or near fire. Doing so may cause electric shock or fire.
- Shut down the product immediately if it produces smoke, a strange odor, or unusual noise. Continued use may cause electric shock or fire. When a fault or other problem occurs, immediately shut down the product and unplug the product. Then, contact qualified service personnel.
- Shut down the product immediately if water or other liquid spills into this product. Continued use may cause electric shock or fire. Immediately unplug the product, and contact qualified service personnel.
- Do not disassemble the areas other than those mentioned in this manual.
- Never repair this product. Tampering with this product may result in injury or fire.
- Do not use this product in an environment where flammable gas or explosive gas may exist. Do not use aerosol sprayers containing flammable gas inside or around this product. Doing so may cause fire.
- Do not connect cables in ways other than those mentioned in this manual. Doing so may cause fire. It may also damage other devices.
- Do not touch the areas inside the product other than those mentioned in this manual. Doing so may cause electric shock or burns.



CAUTION

- Do not allow anyone to stand or place heavy objects on top of this product. Equipment may fall or collapse, causing breakage and possible injury.
- Install the printer, cables and optional products in the proper direction according to the proper procedures. Failure to install correctly may cause fire or injury. Follow the instructions in this manual to install them properly.
- Be sure to disconnect all the cables from the product before you move it. Otherwise the cables could be damaged, potentially resulting in electric shock or fire.
- Be sure to use within the limits of the environmental temperature conditions.

Cautions on the Power Supply for the Single Charger



WARNING

Be sure to use the specified AC adapter (Epson AC adapter C). Using any other power supply could cause faults, fire or electric shock.

Battery Safety Precautions



DANGER

- **Risk of fire and burns.** Do not expose the battery to fire or heat it. This may cause fire, explosion, leakage, overheating or damage.
- Never leave the battery where the temperature may become above 60°C {140°F}. This may cause fire, explosion, leakage, overheating or damage.
- Do not directly solder the battery, and do not disassemble or modify it. This may cause fire, explosion, leakage, overheating or damage.
- Do not connect the terminals together. This may cause fire, explosion, leakage, overheating or damage.
- Do not connect the battery directly to a power outlet or the cigarette lighter of an automobile. This may cause fire, explosion, leakage, overheating or damage.
- If you cannot insert the battery smoothly, do not force it. This may cause fire, explosion, leakage, overheating or damage.
- If any liquid from the battery gets into your eyes, promptly wash it out with clean water for more than 10 minutes and consult your doctor at once. If you do not, the liquid may cause loss of eyesight.
- **Do not crush.** Do not crush the battery or puncture it with a pointed object such as a nail. These may cause fire, explosion, leakage, overheating or damage due to internal short-circuit and heat generation of the battery.



WARNING

- Keep the battery out of the reach of children to avoid harm to the children.
- Do not use the battery with equipment other than TM-P20 printer, OT-SC20 battery charger, or OT-MC20 battery charger. Doing so may cause fire, explosion, leakage, overheating or other damage.
- Unplug the charger if charging is still incomplete after the specified time it should take. Continuing to charge the battery may cause fire, explosion, leakage, overheating or damage.
- Do not expose the battery to water. Do not allow water to contact the terminals. This may cause fire, explosion, leakage, overheating or damage.
- Do not hit or throw the battery. This may cause fire, explosion, leakage, overheating or damage. Do not use the battery if you find something wrong with it such as leakage, color change or deformity.
- Using the charger other than specified may cause fire, explosion, leakage, overheating or damage.
- Keep the battery away from fire or flame if it produces a strange odor or leakage. Otherwise fire, explosion, leakage, overheating or damage may occur.
- Should any battery liquid get on skin or clothing, promptly wash it off with clean water. If you do not, the liquid may damage your skin or clothing.
- Do not short the terminals with any metal objects such as a necklace. This may cause fire, explosion, leakage, overheating or damage, which lead to burn or injury.



CAUTION

- Before using the battery, make sure that its terminals are clean without any foreign substance on them. Dirt and foreign substance on the terminals may cause fire, explosion, leakage, overheating or damage.
- Do not touch the battery right after using it for a long time. It will be hot and may burn you.
- Risk of explosion if battery is replaced by an incorrect type.
- Dispose of used batteries according to the instructions.
- Be sure to use within the limits of the environmental temperature conditions.

Cautions for Use and Storage of the Battery



- Do not pull or push the battery hook forcefully.
- Keep the battery terminals clean, so that no dirt or foreign material becomes attached.
- When cleaning the battery, do not use any solvents, such as alcohol, benzine, or thinner. Doing so may deform or damage the plastic sections. Wipe off any dirt using a dry cloth.
- The battery slowly loses power while it is not being used.
- When charging the battery, charge it in an environment that is between 10°C and 30°C.
- To prevent deterioration in the battery performance, avoid direct sunlight, high temperatures, and high humidity, and store it in a cool location (around 20°C).
- If storing it for a long period of time, remove it from the printer or battery charger. Also, to prevent deterioration in its performance, we recommend that you charge it approximately once per year.
Guide for charging: Battery charge status Level L
For details about the charge level, refer to the printer's User's Manual.
- If the battery life is remarkably short, the battery may have expired. Replace it with a new battery.

Restriction of Use

When this product is used for applications requiring high reliability/safety, such as transportation devices related to aviation, rail, marine, automotive; disaster prevention devices; various safety devices; or functional/precision devices, etc., you should use this product only after giving consideration to including fail-safes and redundancies into your design to maintain safety and total system reliability. Because this product was not intended for use in applications requiring extremely high reliability/safety, such as aerospace equipment, main communication equipment, nuclear power control equipment, or medical equipment related to direct medical care, etc., please make your own judgement on this product's suitability after a full evaluation.

Note about interference

- This product generates, uses, and can radiate radio frequency energy and, if not installed and used in accordance with the instruction manual, may cause harmful interference to radio communications.
- If this equipment does cause harmful interference to radio or television reception, which can be determined by turning the equipment off and on, the user is encouraged to try to correct the interference by one or more of the following measures:
 - Reorient or relocate the receiving antenna for the radio/TV.
 - Increase the separation between the equipment and the radio/TV.
 - Consult your dealer or an experienced radio/TV technician for help.
- Never disassemble or modify this product.
- Seiko Epson Corporation shall not be liable for interference to radio/TV resulting from changes or modifications to this product not expressly approved by Seiko Epson Corporation.

About this Manual

Aim of the Manual

This manual was created to provide information on the development, design, and installation of POS systems and the development and design of printer applications for developers.

Manual Content

The manual is made up of the following sections:

Chapter 1	Product Overview
Chapter 2	Setup
Chapter 3	Advanced Usage
Chapter 4	Application Development Information
Chapter 5	Handling
Appendix	Product Specifications Specifications of Interfaces and Connectors Character Code Tables



Contents

■ For Safety	3
Key to Symbols	3
Cautions on Handling the Printer	4
Cautions on Installation of the Printer	4
Cautions on Handling the Single Charger	5
Cautions on the Power Supply for the Single Charger	5
Battery Safety Precautions	6
Cautions for Use and Storage of the Battery	7
■ Restriction of Use	8
■ Note about interference	8
■ About this Manual	9
Aim of the Manual	9
Manual Content	9
■ Contents	11

Product Overview 15

■ Features	15
■ Product Configurations	16
Interfaces	16
NFC Tag	16
Accessories	16
■ Part Names and Functions	18
Offline	21
■ Power Functions	22
Auto-Power Off	22
Battery Charge Modes	22
■ Operation Mode When Battery is Low	23
Mode 1	24
Mode 2	25
■ Error Status	26
Automatically Recoverable Errors	26
Recoverable Error	26
Unrecoverable Errors	27
■ NV Memory	28
NV Graphics Memory	28
User NV Memory	28
Customized Values and Memory Switches	28
User-defined Page	28
Maintenance Counter	29

■ Useful Functions for Smart Devices	30
NFC Tag.....	30
QR Code	30

Setup..... 31

■ Flow of Setup	31
■ Installing the Printer	32
Installing the Battery	33
Installing or Replacing the Roll Paper	35
■ Connecting the Printer	39
USB Interface.....	39
Wireless LAN Interface	40
Bluetooth Interface	43

Advanced Usage..... 47

■ Software Settings	47
■ Paper Layout Setting	53
■ Settings/Check Mode	54
Self-test mode.....	55
NV graphics information print mode	56
Software settings mode	56
Radio field intensity check mode.....	58
Wireless module setup mode.....	59
Hexadecimal dumping mode	61
■ Dynamic Status Sheet Print Mode	63
Wi-Fi Model	63
Bluetooth Model	64
■ EpsonNet Config (Web Version)	65
Starting EpsonNet Config (Web Version)	65
Settings	66

Application Development Information.....69**■ Controlling the Printer 69**

ePOS-Print XML.....69

ESC/POS.....69

■ Software and Manuals 70

Development Kits70

Drivers71

Utilities71

Others.....72

Download72

■ Application Development and Distribution for iOS..... 73

Handling75**■ Charging Battery 75**

Using the printer itself.....76

Battery's charging status77

Battery malfunction78

Using the battery spacer (OT-BS20).....79

■ Cleaning the Printer..... 80

Cleaning the Printer Case.....80

Cleaning the Thermal Head.....80

Cleaning the Platen Roller/Paper Sensor.....81

Cleaning the Charge Terminals.....81

Appendix.....83**■ Product Specifications 83**

Printing Specifications.....83

Character Specifications84

Paper Specifications.....86

Printable Area88

Printing and Cutting Positions88

Electrical Characteristics89

Reliability.....89

Environmental Conditions.....89

External Dimensions and Mass91

Colors.....91

■ Specifications of Interfaces and Connectors 92

USB Interface92

Wireless LAN Interface.....93

Bluetooth Wireless Interface96

NFC Tag99

■ Character Code Tables..... 100



Product Overview

This chapter describes features and specifications of the TM-P20, a portable receipt printer.

Features

TM-P20 is a thermal mobile printer. The main features of this product are as follows.

Printing

Maximum printing speed of 100 mm/s is possible.

Printer handling

- Compact body (Approximately 221 g/Wi-Fi[®] model, Approximately 212 g/*Bluetooth*[®] model)
- Drop impact resistance from a height of 2 m (compliant with JIS C60068-2-31: 2013)
- Dust-proof performance (IP4X equivalent)
- Soft case for higher dust-proof and splash-proof performance (IP54)
- Easy drop-in paper loading
- Belt clip for improved portability in a mobile environment
- The direct connection without Wi-Fi access point brings a simplified configuration procedure of network settings. (SimpleAP mode)

Software

- NFC tag built into the printer unit for printing to a touched printer
- Printing triggered by bar code scan by smart device camera
- Utility for iOS/Android provides a user-friendly wizard to simplify the connection for smart devices (Epson TM Utility for iOS/Android™)

Interfaces

- Either wireless LAN interface (IEEE802.11a/b/g/n) or *Bluetooth* interface is installed by factory option.
- USB interface is standard equipment.

Environment

Has a paper-saving function.

Product Configurations

Interfaces

- Wi-Fi model (IEEE802.11 + USB)
- *Bluetooth* model (*Bluetooth* + USB)

NOTE

Wireless or USB is available. When you connect to the host with a USB cable and the printer is turned on, the USB interface is selected.

NFC Tag

You can perform wireless setup for terminals that support NFC by placing the terminal close to the NFC tag (mark) on the printer.

* There is no Read/Write function.

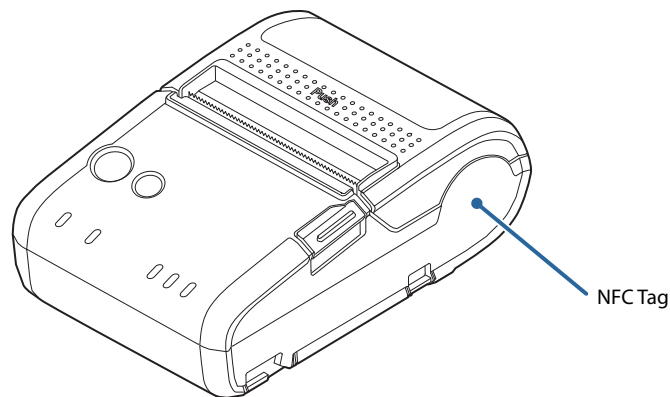

Accessories

Included

- Thermal roll paper (for operation check)
- Battery (OT-BY20)
- Single charger (OT-SC20)
- AC adapter (AC adapter, C)
- AC cable ^{*1}
- Belt clip (attached to the printer)
- USB cable (1.2m {4 feet} long)
- Setup Guide (Wi-Fi / *Bluetooth*)
- CD-ROM
- Warranty certificate ^{*2}

*1 May vary depending on the model or region.

*2 May not be included, depending on the model.

Options

- Battery (OT-BY20)
- Single charger (OT-SC20)
- Quad charger (OT-MC20)
- Battery spacer (OT-BS20)
- Soft case (OT-PC20)

Part Names and Functions

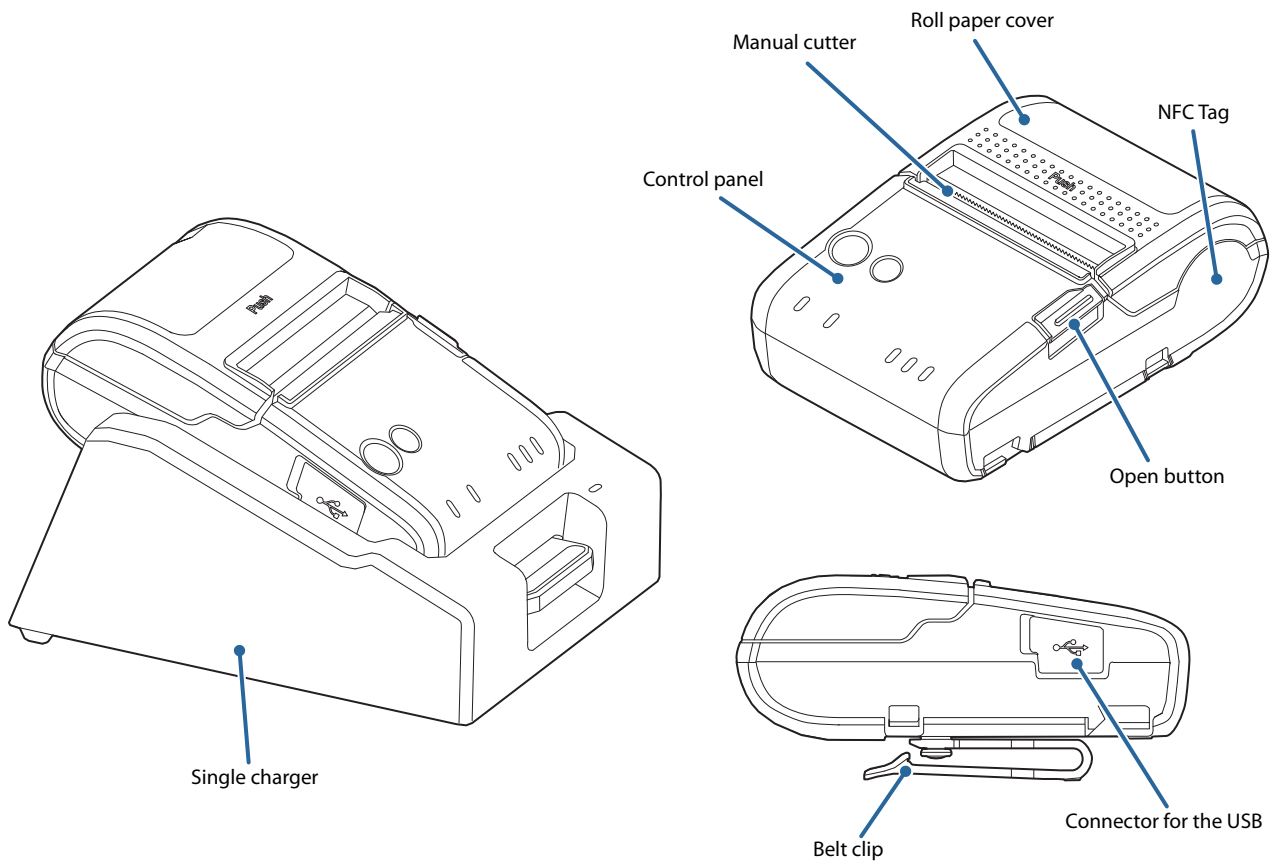

Roll Paper Cover

Open this cover to install or remove the roll paper.

Open Button

Push this button to open the roll paper cover.

Connector for the USB

Connect the USB interface cable.

Belt clip

Use this clip to hang the printer on your belt.

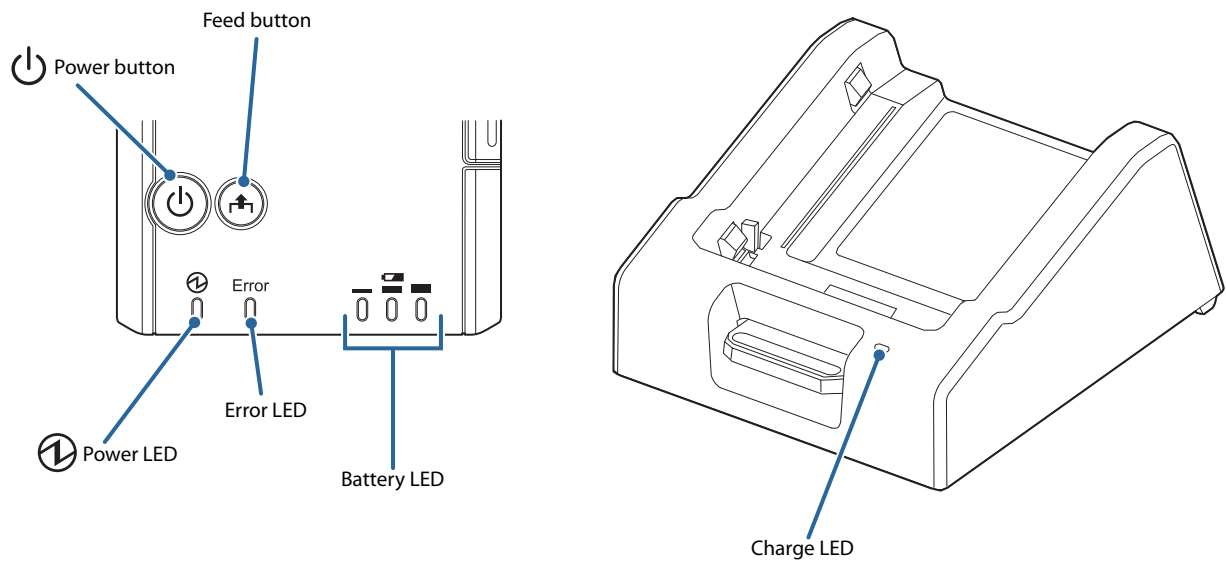

Buttons

Power Button

Press this button to turn the printer on. Press this button for 2 seconds or more to turn the printer off.

CAUTION

- After the power button is pressed, it takes the following time before the printer is initialized. Establishing a wireless communication takes longer than the following.
 - * IEEE802.11a/b/g/n: Approx. 10 sec. after the Power LED comes on.
 - * *Bluetooth*: Approx. 2 sec. after the Power LED comes on.
- The printer does not operate and the LEDs go out when the battery is not installed in the printer.
- To turn the printer on immediately after turning the printer off, wait until the LEDs go off.

Feed button

- When Paper Type Setting is set to Receipt paper (without black mark), pressing this button once feeds paper by one line. Holding this button down feeds paper continuously.
- When Paper Type Setting is set to Receipt paper (with black mark), pressing this button feeds paper to the print starting position on the next black mark.

NOTE

Enabling/disabling of the Feed button can be selected by a command. If the command is set to disable the button, it does not function.

LEDs

① Power LED (Blue)

CAUTION

The printer does not operate and the LEDs go out when the battery is not installed in the printer.

- Lights when the power is on.
- Goes out when the power is turned off.
- Flashes when the printer is powering-off or while the Feed button is being pressed in the software setting mode. With the Wi-Fi model, it flashes also when the printer is being initialized after the power is turned on.

Error LED (Orange)

- Lights when the printer is offline. (For details about offline, see ["Offline" on page 21.](#))
- Flashes when an error occurs. (For details about the flash codes, see ["Error Status" on page 26.](#))
- Goes out during normal operation (online).

Battery LED (Blue)

The remaining battery charge is indicated by three LEDs only when the battery is installed in the printer. For details, see ["Operation Mode When Battery is Low" on page 23.](#)

Charge LED (Orange)

The Charge LED is located on the single charger (OT-SC20) and quad charger (OT-MC20).

- Lights when the battery is being charged.
- Off when the battery is not being charged.
- Flashes when there is abnormality in battery charging.

Offline

The printer automatically goes offline and stops printing under the following conditions. Once all of the following conditions are cleared, the printer becomes online and ready to print.

- During power on until the printer is ready
- While roll paper is being fed using the Feed button
- When the roll paper cover is open
- When paper is out
- When an error has occurred
- While waiting for the switch for executing the macro to be on
- While the printer is shutting down
- When the remaining battery charge is at level E
- When the battery malfunction is detected

NOTE

- The Error LED lights during offline. However, it flashes when an error has occurred.
- For details about the battery charge levels and operation modes, see "[Operation Mode When Battery is Low](#)" on page 23.
- You can select whether or not to stop command processing off-line with the customized value. To set the customized value, see "[Software Settings](#)" on page 47.
- The buzzer beeps five times when there is no more paper or an error has occurred. You can disable the buzzer with the memory switches. For details on the memory switch settings, see "[Software Settings](#)" on page 47.

Power Functions

You can customize the printer using the power functions, the auto-power off function and battery charge mode function to save the battery power or minimize the battery deterioration.

Auto-Power Off

The printer automatically turns off once the specified time has elapsed in the idle state.

However, when the printer is in the following status, it is not considered as idle state, and the auto-power off function is not applied.

- Printer is off-line
- Remaining battery amount is at S level

NOTE

The auto-power off time is selectable with the customized value. To set the customized value, see ["Software Settings" on page 47](#).

Battery Charge Modes

The printer has two battery charge modes and is initially set to the mode 1.

NOTE

The battery charge mode is selectable with the customized value. To set the customized value, see ["Software Settings" on page 47](#).

Mode 1

Suitable for battery-powered operation.

In Mode 1, battery charging is controlled so that the battery is always fully charged.

Mode 2

Suitable for the printer that is always connected to the single charger.

In Mode 2, battery charging is controlled so that the battery is about 80% charged.

Operation Mode When Battery is Low

There are two operation modes for the printer when the battery is low. Change the mode depending on the usage status.

Mode 1 (initial setting):

Continues printing until the remaining battery becomes approximately 0%. This is appropriate if you want to maximize the battery operation time. However, the printer may stop during the printing or print quality may decrease when the remaining battery becomes near 0%.

Mode 2:











Stops printing when the remaining battery becomes approximately 10%. This is appropriate if you want to avoid that the printer stops during the printing.

NOTE

- When the amount of charge remaining in the battery reaches the L level, we recommend replacing or charging the batteries.
- When the amount of charge remaining in the battery reaches the S or E level, we recommend replacing or charging the batteries.
- The operation mode when battery is low is selectable with the customized value. To set the customized value, see ["Software Settings" on page 47](#).
- The buzzer beeps five times when the remaining battery charge goes down to the levels L or S. You can disable the buzzer with the memory switches. To set the memory switches, see ["Software Settings" on page 47](#).
- Before printing starts, the amount of charge remaining in the battery is detected, and the display is updated after printing. The battery LED display does not detect the amount of charge remaining in the battery in real time.

Mode 1



	Battery LED	Error LED	Remaining battery charge	Printing	Communication
Level H			Approx. 60 ~ 100%	Possible	Possible
Level M			Approx. 20 ~ 60%	Possible	Possible
Level L			Approx. 10 ~ 20%	Possible	Possible
Level S			Approx. below 10%	Possible*	Possible
Level E			Approx. 0%	Impossible	Impossible

* Printing may be interrupted.

Mode 2



	Battery LED	Error LED	Remaining battery charge	Printing	Communication
Level H			Approx. 60 ~ 100%	Possible	Possible
Level M			Approx. 40 ~ 60%	Possible	Possible
Level L			Approx. 20 ~ 40%	Possible	Possible
Level S			Approx. 10 ~ 20%	Possible	Possible
Level E			Approx. below 10%	Impossible	Impossible

Error Status

When an error occurs, the printer stops printing, goes offline, and the Error LED flashes.

There are three error types: automatically recoverable errors, recoverable errors, and unrecoverable errors.

Automatically Recoverable Errors

Printing is temporarily suspended when automatically recoverable errors occur. They can recover automatically, as described below.

Error	Error description	Error LED flash code	Recovery measure
Paper error	The black mark cannot be detected.		Recovers automatically when the cover is opened.
Temperature error	The temperature of the print head, motor driver IC, or battery is high.		Recovers automatically when the temperature goes down.

Recoverable Error

Printing is no longer possible when a recoverable error occurs. They can be recovered easily by sending an error recovery command after eliminating the cause of the error.

Error	Error description	Error LED flash code	Recovery measure
Paper layout error	The paper layout differs from the actual paper. Paper jam occurs.		Recovers by sending an error recovery command ("DLE ENQ").





CAUTION

The error recovery command is valid only if a recoverable error (excluding automatically recoverable errors) occurs.

Unrecoverable Errors

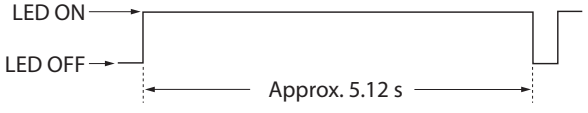
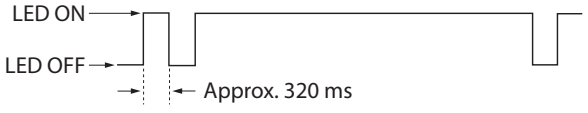
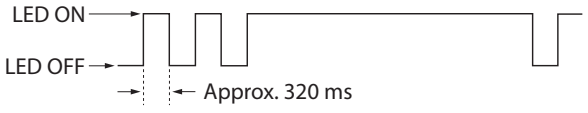
Printing is no longer possible when unrecoverable errors occur. If the same error occurs again even after turning the power back on, contact qualified service personnel.

 CAUTION	Immediately turn off the power and remove the battery when unrecoverable errors occur.
---	--

Error	Error description	Error LED flash code
Internal circuit error	Internal circuits are not connected correctly.	
R/W error in memory	After R/W checking, the printer does not work correctly.	
High voltage error	The power supply voltage is high.	
Overload error	The temperature of the print head or battery is extremely high or low.	
CPU execution error	The CPU is executing an incorrect address.	
Wireless communication unit error	Wireless communication does not work correctly or the wireless communication unit is disconnected.	

NV Memory

The printer's NV memory (Non-Volatile memory) stores data even after the printer power is turned off. NV memory contains the following memory areas for the user:

- NV graphics memory
- User NV memory
- Customized values and memory switches
- User-defined page
- Maintenance counter

CAUTION

As a guide when you program applications, NV memory should be rewritten 10 or fewer times a day.

NV Graphics Memory

Graphics, such as shop logos to be printed on receipts, can be stored. Even if communication speed is low, high speed graphic printing is possible.

Use the TM-P20 Utility to register graphics. You can also print and confirm the registered graphics in the TM-P20 Utility or NV graphics print mode.

NOTE

- For detailed information about the TM-P20 Utility, see the TM-P20 Utility User's Manual.
- To use the NV graphics print mode, see ["NV graphics information print mode" on page 56](#).

User NV Memory

You can store and read text data for multiple purposes, such as for storing a note including customizing or maintenance information of the printer.

Use ESC/POS commands to store and read the text data.

NOTE

For detailed information about ESC/POS commands, see the ESC/POS Command Reference (see ["ESC/POS" on page 69](#)).

Customized Values and Memory Switches

With the customized values and memory switches, which are software switches for the printer, you can configure various settings of the printer.

To set the customized values and memory switches, see ["Software Settings" on page 47](#).

User-defined Page

You can store character data in the user-defined page (character code table: page 255) so that you can also print characters not resident in the printer.

Maintenance Counter

With this function, printer information, such as the number of lines fed, and printer operation time after the printer starts working, is automatically stored in NV memory. You can read or reset the information with TM-P20 Utility, the Status API of the APD, or OPOS ADK to use it for periodical checks or part replacement.

NOTE

Maintenance counter values are usually saved every two minutes except in the power saving status. However, if the printer power is turned off by removing the battery or using up the battery charge, the latest maintenance counter will not be saved. For detailed information about ESC/POS commands, see the ESC/POS Command Reference (see ["ESC/POS" on page 69](#)).

Useful Functions for Smart Devices

You can easily connect this product to the network by using the NFC tag built-in to the printer or the QR code printed on the status sheet.

NFC Tag

Bring a smart device that supports NFC close to the NFC tag to acquire the printer information (information for specifying the device).

Specify the target printer using the acquired information to connect to the network.

QR Code

Capture the QR code printed on the status sheet with the camera on your smart device to acquire the printer information (information for specifying the device).

Specify the target printer using the acquired information to connect to the network.

NOTE

- Programming using Epson ePOS SDK is required to use these functions. These functions are created by combining NFC touch and QR code capturing operations and the target printer specifications using Printer Easy Select API.
See the "Epson ePOS SDK for Android/iOS User's Manual" and the Epson ePOS SDK sample program for more details. The sample program also contains a sample implementation method for reading an NFC tag and capturing a QR code.
- You can try a demo of these functions by using Epson TM Utility for iOS/Android.

Setup

This chapter describes setup and installation of the product.

Flow of Setup

This chapter consists of the following sections, along with the setup flow of the product. The TM-P20 has dual interfaces: a built-in USB interface and another interface selected by the customer, wireless LAN or *Bluetooth* interface. See the corresponding section for the interface you selected.

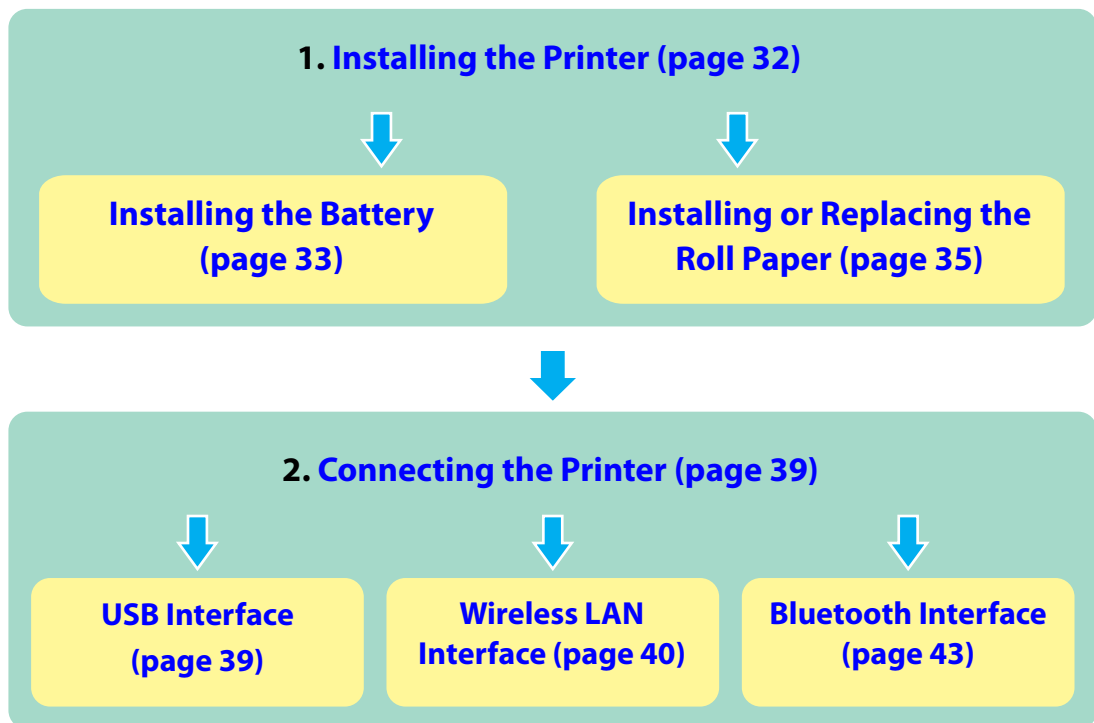

Installing the Printer

You can install the printer (1) horizontally or (2) vertically. You can also carry it using the belt clip on the back of the printer to hang the printer on your belt.

CAUTION

- When you install the printer horizontally, it is recommended to remove the belt clip. Remove the two screws fixing the clip to remove it.
- When you install the printer vertically, only the orientation shown below is available. Do not install the printer upside down.

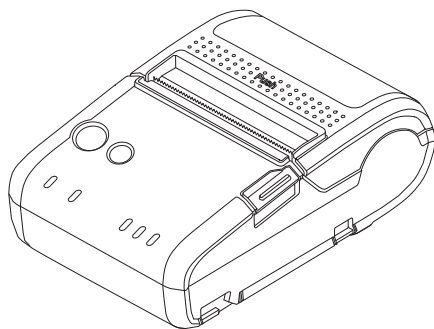

(1) horizontally

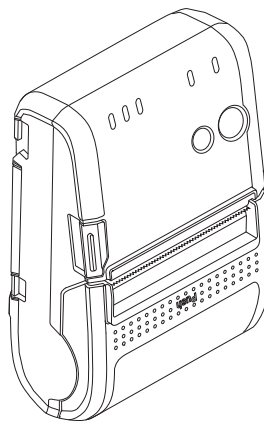

(2) vertically

Installing the Battery

The printer does not operate without a charged battery installed.

Follow the steps below to install the battery.



Be sure to use the battery OT-BY20.

Using a battery other than the one specified may cause fire, explosion, leakage, overheating or other damage.

CAUTION

- When removing the battery, be sure to turn off the power before doing so.
- Dispose of used batteries according to the instructions.

- 1 Make sure that the printer is turned off.
- 2 When the belt clip is attached, turn the belt clip in the direction of the arrow, and change to the status in which the battery can be removed.

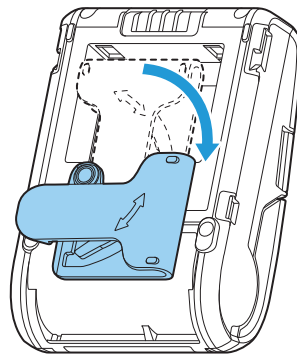

- 3 Remove the hook for the battery, and then remove the battery.

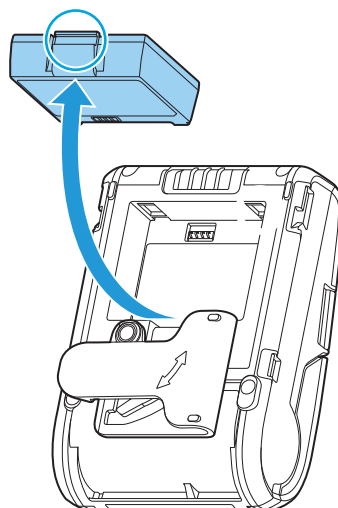

- 4** Install the battery. Insert the battery with its tabs fitted into the printer's grooves, until it clicks firmly into place in the holder.

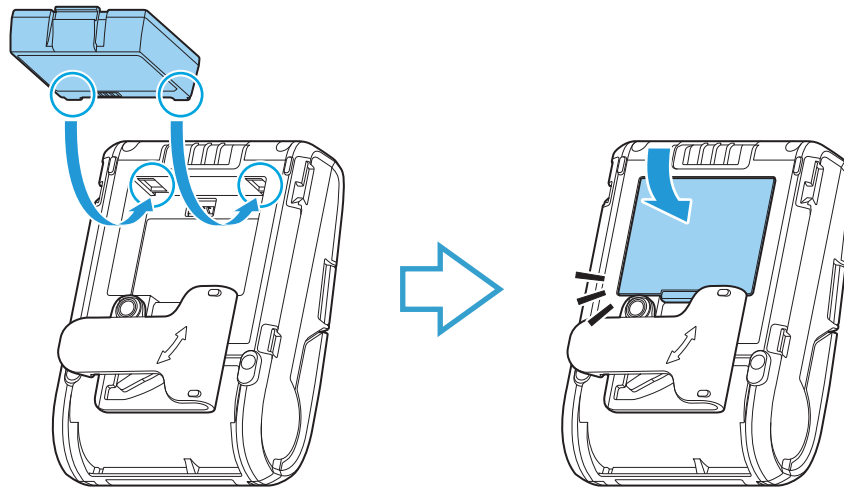

- 5** Return the belt clip to its original position.

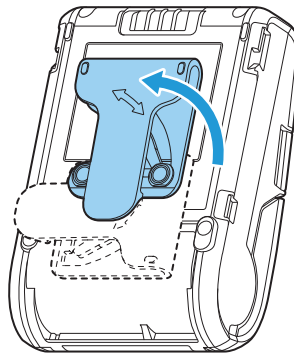

NOTE

To charge the battery, see "[Charging Battery](#)" on page 75.

Installing or Replacing the Roll Paper

Follow the steps below to install or replace the roll paper.



Do not touch the manual cutter when inserting or replacing paper. Your hand could be injured on the manual cutter.

CAUTION

- Use paper that meets the printer specifications. For details about paper specifications, see "[Paper Specifications](#)" on page 86.
- Paper must not be pasted to the roll paper spool.
- If the roll paper is loosely rolled up, pull on the end until it is tight before installation. Installing the roll paper while it is loosely rolled up may lead to a paper jam or poor printing quality.

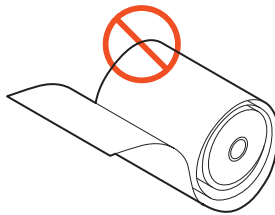

When Installing the Printer Horizontally

- 1 Press the open button to open the roll paper cover.

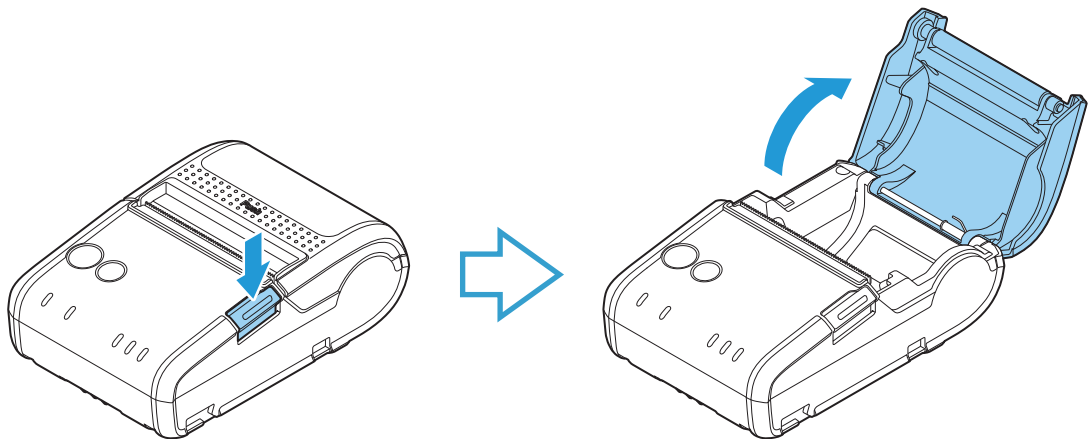

- 2 Remove the used roll paper core, if there is one.

3 Insert the new roll paper in the correct direction and pull out some paper.

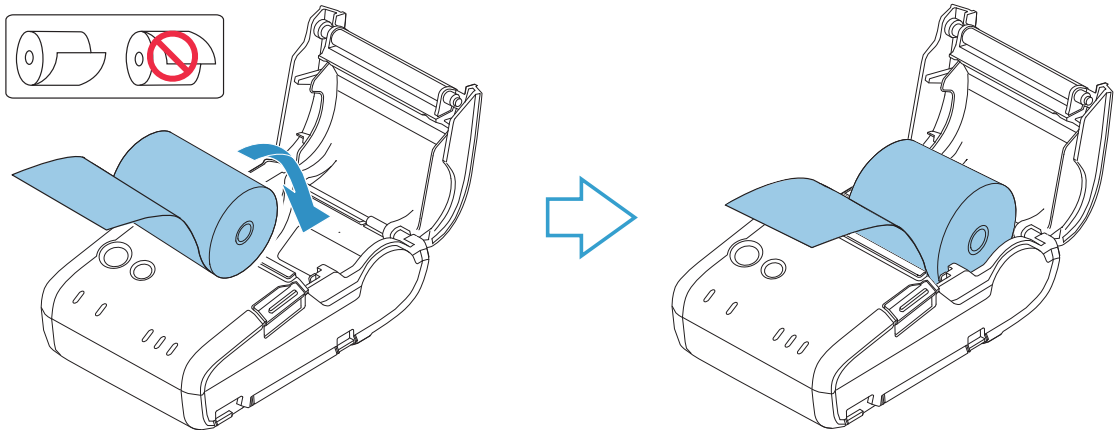

4 Close the cover and tear off the paper.

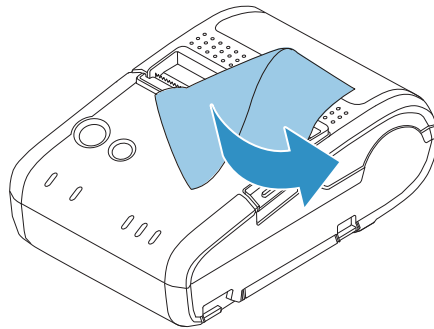

When Installing the Printer Vertically

1 Press the open button to open the roll paper cover.

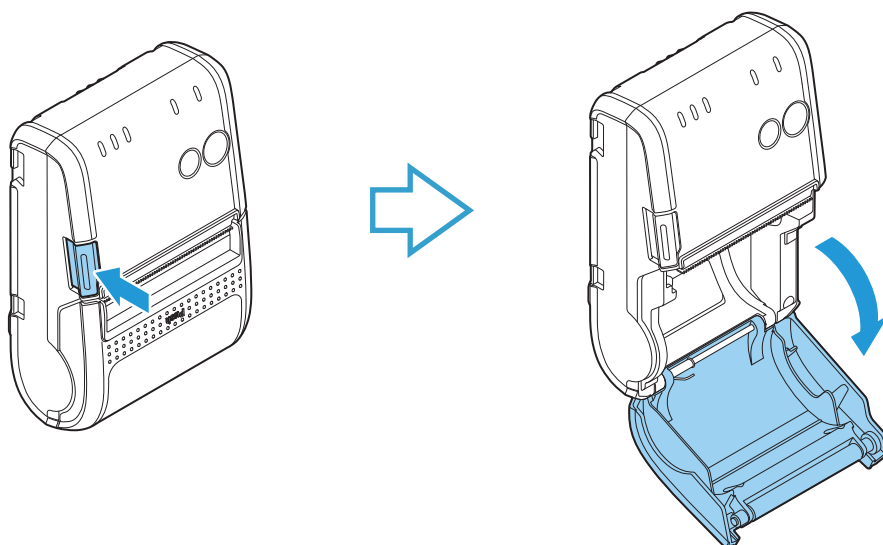

- 2 Remove the used roll paper core, if there is one.
- 3 Set the new roll paper in the correct direction.

CAUTION

When installing vertically, install so that the roll paper side is facing down.

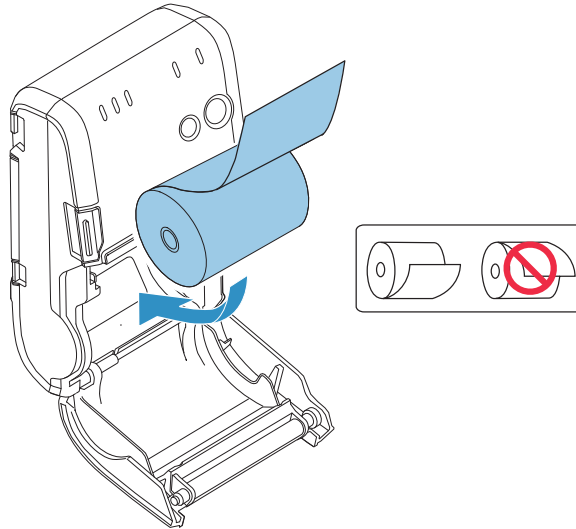

- 4 Pull the leading edge of the roll paper. Also, align the left edge of the roll paper with the end of the roll paper cover.

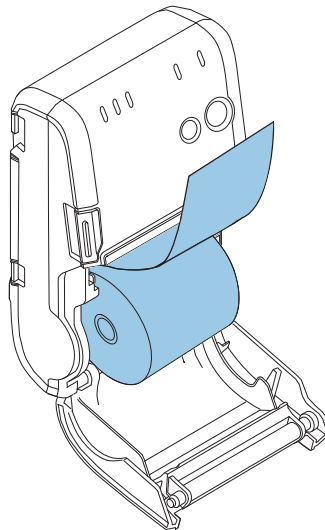

5 Close the cover and tear off the paper.

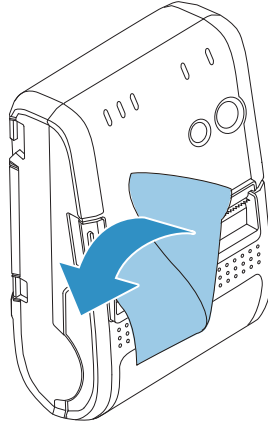

Connecting the Printer

CAUTION

- Before connecting the printer, confirm the current interface mode. The printer is initially set to the Automatic selection mode. To change the interface mode, see ["Software Settings" on page 47](#).
- **Automatic selection:**
When the USB cable is connected with a host PC, the USB interface is preferentially selected. Otherwise, the wireless LAN/*Bluetooth* interface is selected. Once the interface is selected, the selection is enabled until the power is turned off or the USB cable is disconnected.

USB Interface

When communicating with a host PC via the USB cable, connect the USB cable to the printer, turn on the PC, and then turn on the printer.

CAUTION

Do not place any weight or stress on the cable when using. Doing so could damage the cable and connectors.

- 1** Connect the USB cable from the host computer to the USB connector.
- 2** Connect the other end of the interface cable to the host computer.
- 3** Turn on the host computer.
- 4** Turn on the printer.

Wireless LAN Interface

Using Epson TM Utility, you can easily connect the printer to the network from an iOS or Android devices. We also recommend connecting using a USB cable from a Windows computer, and setting up the wireless LAN using the network setup tool (EpsonNet Config).

CAUTION

- When you set up the access point at the same time, set the access point in advance and check that it operates correctly.
- Examine the radio wave situation in the surrounding area before use.
- Avoid using the same channel that is used in the neighboring shops where wireless LAN is used.
- When using the printer in environments where kitchen microwaves and other devices that may interfere radio waves are installed, observe the following points.
 - * Keep the printer away from the devices, such as kitchen microwaves, that may cause radio wave interference.
 - * Use channels that are away from the frequency bands that may cause radio wave interference.
 - * Place shields between the printer and the devices that may cause radio wave interference.
 - * Select either 2.4 GHz or 5 GHz, whichever is free from radio wave interference.
 - * In auto channel setting for the access point, do not select a channel in which the devices may cause radio wave interference.
- In the infrastructure mode, W53 and W56 channels are not available to connect to a stealth SSID access point.

Setting up from a Smart Device

Necessary Items

Prepare the following items.

- Printer: TM-P20
- Device for setting: iOS or Android device
- Utility for setting: Epson TM Utility for iOS/Android

Running Epson TM Utility for iOS/Android

- 1** Run the Epson TM Utility for iOS/Android.



- 2** Set from “Wi-Fi® Setup Wizard” in the menu.

Setup and Operation Work flow

1. Select the network you want to connect to.
2. Enter the passkey.
3. Perform a test print.

Setting up from a Windows Computer

Necessary Items

Prepare the following items.

- Printer: TM-P20
- Computer for setting: Windows 10/8/7/Vista/XP
- Utility for setting: EpsonNet Config
- USB cable (Mini-B)

Installing the EpsonNet Config to the computer used for setting

Download the EpsonNet Config and install it in the computer, following the on-screen instructions. (See the EpsonNet Config manual (operation guide) or the EpsonNet Config online help for information on how to use the EpsonNet Config after you have installed it.)

Follow the steps below to connect the printer.

1 Connect the printer to a PC via the USB cable.

See "[USB Interface](#)" on page 39.

2 Turn on the host computer.

3 Turn on the printer.

4 Start up the EpsonNet Config.

CAUTION

When the EpsonNet Config is started up, the battery LED (the remaining battery charge is indicated) goes off and the Feed button is disabled.

5 Double-click on the printer.



6 Configure the [Network] settings and the [TCP/IP] settings.

7 Disconnect the USB cable, turn off the printer, and then turn it back on.

CAUTION

To start wireless LAN communication, be sure to disconnect the USB cable, turn off the printer, and then turn it back on.

NOTE

If you need to configure other settings, use EpsonNet Config (web version). For information about EpsonNet Config (web version), see "[Starting EpsonNet Config \(Web Version\)](#)" on page 65.

Confirming the operation

Confirm that the printer is connecting to the network. There are the following methods:

- Confirm using a web browser
- Confirm using EpsonNet Config
- Confirm using the PING command from the command prompt

This section describes how to confirm using a web browser.

1 Confirm that the network is running; then start up the computer of the network.

2 Start up the web browser and input the printer's IP address in the address bar.

http://(printer's IP address)/

The "EpsonNet Config" window is displayed.

If the "EpsonNet Config" window is not displayed, connect the computer for setting to the printer with the USB cable, then confirm the setting again.

Bluetooth Interface

Use a tool, such as a built-in *Bluetooth* connection tool of your device to establish the connection with the printer. If your device is a Windows computer, use EPSON™ *Bluetooth*® Connector, which is a utility to easily pair a terminal and the printer. If your terminal is an iOS or Android terminal, use Epson™ Utility to easily pair your terminal and the printer.

CAUTION

- If the host computer and the printer are not connected on a continuous basis but rather connected every time the printer starts printing, some time may be needed for the printer to actually start printing after the host computer commands printing. This pause is the time required for processing the connection between the host computer and the printer, and it depends on the conditions of the environment where used.
- If data transfer from an application of the host computer has already been completed, data might remain in the *Bluetooth* module internal buffer. As such data remaining in the buffer might be lost when the connection is cut off, use the status or similar functions to check that transmitted data has been completely printed before cutting off the wireless connection.

NOTE

- For detailed information about EPSON™ *Bluetooth*® Connector, see the *TM Bluetooth*® Connector User's Manual.
- The device name and passkey are editable with the TM-P20 Utility.

2

Setting up from a Smart Device

Necessary Items

Prepare the following items.

- Printer: TM-P20
- Device for setting: iOS or Android device
- Utility for setting: Epson™ Utility for iOS/Android

Running Epson™ Utility for iOS/Android

- 1 Run the Epson™ Utility for iOS/Android.



- 2 Set from “Bluetooth® Setup Wizard” in the menu.

Setup and Operation Work flow

1. Select the printer you want to connect to.
2. Enter the passkey.
3. Perform a test print.

Setting up from a Windows Computer

Follow the procedure below and make the settings.

- 1 Have a *Bluetooth* wireless technology compatible computer ready.**
Make sure you have installed TM *Bluetooth*® Connector.
- 2 Turn on the printer.**
- 3 Start TM *Bluetooth*® Connector.**
- 4 Select [Search all printers around this computer], and then click [Search].**

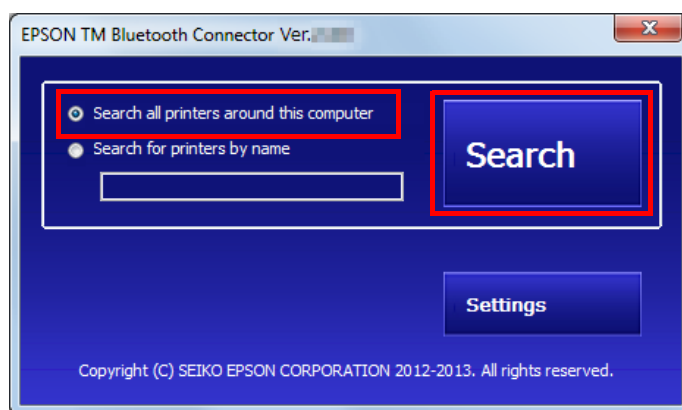

NOTE

If the printer has not detected after clicking the Search button, check the manufacturer of the *Bluetooth* software.

1. Open the Control Panel.
2. In the search box on the Control Panel, enter "Bluetooth", and then click Change Bluetooth settings.
3. In the Bluetooth Settings dialog box, click the Hardware tab, and then search for the Microsoft Bluetooth Enumerator. If it is not found, the *Bluetooth* software cannot detect the Epson *Bluetooth* printer, and you may not be able to connect to the computer.

- 5 Select the printer to be paired (→ Not been paired yet), and then click [Connect].

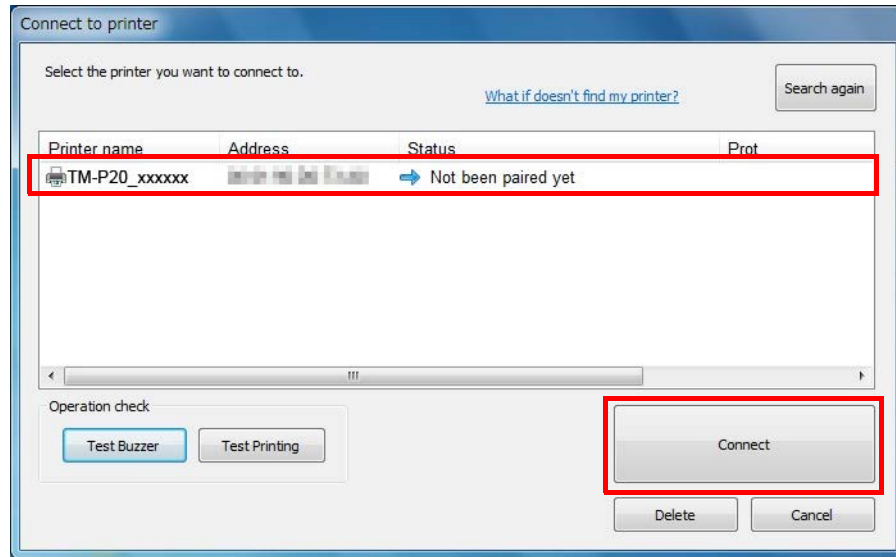

- 6 If the window to enter a passkey appears, enter a passkey and click [OK].
- 7 Select the port to be used from the pull-down list, and then click [OK].

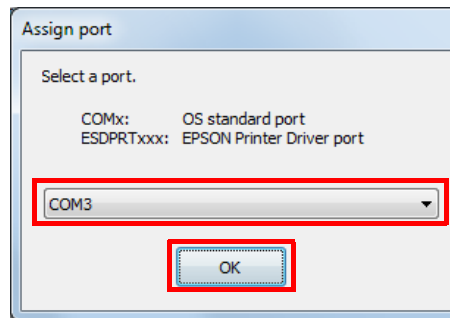

Printing method	Port name
APD print queue	ESDPRTxxx (TM-P20: Queue name)
UPOS	ESDPRTxxx (UPOS for TM-P20)
ESC/POS command	Displayed virtual COM port (e.g. COM4)

- 8 The “Connection complete” window appears. Click [Test Buzzer] or [Test Printing] to check operation.
- 9 Click [Back to Main screen] to return to the main window.
- 10 Click the “x” button of TM *Bluetooth*® Connector to exit.

NOTE

- If “Error” is displayed when you click the [Search] on the TM *Bluetooth*® Connector, check whether:
 - * The *Bluetooth* adapter is installed to the computer.
 - * Bluetooth is ON in the Windows settings.
- If the device is not displayed on the TM *Bluetooth*® Connector or the TM *Bluetooth*® Connector Status shows “✘” after pairing.
Check whether:
 - * The printer is not turned on.
Turn on the printer. Confirm that the battery is properly loaded in the printer.
 - * The printer is 10 m or further away from the computer.
 - * Confirm that there is no other wireless device, such as a microwave oven and cordless telephone, that can interfere with the *Bluetooth* printer.
 - * If the printer and the computer are placed in different rooms separated by a wall, move the printer and/or the computer in the same room.
 - * The printer may not be detected when the search time is short. Try search again with longer search time.
 - * While a computer and printer are communicating, the printer cannot be detected by other computers. Confirm that the printer to be detected is not communicating with any computer.

Advanced Usage

This section explains advanced usage methods for the product.

Software Settings

With the customized values and memory switches, which are software settings for this printer, you can set the various functions. For an outline of those functions, see the following section. Use TM Utility for iOS, TM Utility for Android, TM-P20 Utility for Windows, or Software setting mode to set the customized values and memory switches.

		TM Utility for iOS, for Android	TM-P20 Utility for Windows	Software setting mode
Customized values	User NV memory capacity			✓
	NV graphics memory capacity			✓
	Print density	✓	✓	✓
	Print speed	✓	✓	✓
	Interface selection			✓
	Command execution during offline	✓	✓	✓
	Automatic paper reduction		✓	✓
	Automatic power off setting	✓	✓	✓
	Battery charge mode	✓	✓	
	Operation mode when battery is low	✓	✓	
Memory switches	USB power-saving function	✓	✓	
	Transmission of status notice	✓	✓	✓
	Buzzer settings	✓	✓	✓
	Error signal output	✓	✓	
	Paper position immediately after specific state	✓	✓	✓
Communication conditions using a USB interface			✓	✓
Communication conditions using a Bluetooth interface			✓	
Desktop Mode setting*		✓	✓	✓

* : Enabled only under the following conditions.
 Epson TM Utility for iOS/Android Ver.3.10.0 or later
 TM-P20 Utility for Windows Ver.1.20 or later
 Firmware version 1.05 ESC/POS or later

NOTE

- For detailed information about TM-P20 Utility, see the TM-P20 Utility User's Manual.
- For information about how to use the Software setting mode, see "[Software settings mode](#)" on page 56.

User NV memory capacity

- 1 KB (initial setting)
- 64 KB
- 128 KB
- 192 KB

NV graphics memory capacity

- None
- 64 KB
- 128 KB
- 192 KB
- 256 KB
- 320 KB
- 384 KB (initial setting)

Print density

Selectable from levels 1 to 13 (70% ~ 130%) (initial setting: level 7)

Depending on the paper type, it is recommended to set the print density as shown in the table below for the best print quality.

Original Paper Type	Density Level
P35024, KT55F20, KT48F20, AF50KS-E	7 (100%)
F5041(48), F5041(55)	8 (105%)
P30023, P31023	12 (125%)

CAUTION

- If the print density is set to a darker level, printing speed may be reduced.
- If the print density is set to a darker level, paper dust accumulates on the print head and print may be faint. For information about how to clean the thermal head, see "[Cleaning the Printer](#)" on page 80.

Print speed

Selectable from levels 1 to 10 (Slow ~ Fast) (initial setting: level 10)

NOTE

Depending on print conditions, such as print duty, print head temperature, and data transmission speed, print speed is automatically adjusted, which may cause white lines due to intermittent print (the motor sometimes stops). To avoid this, keep the print speed constant by setting it lower.

Interface selection

Selectable from: automatic selection, fixed to wireless LAN/*Bluetooth* interface, or fixed to built-in USB.

NOTE

- The TM-P20 has dual interfaces: a built-in USB interface and another interface selected by the customer, wireless LAN or *Bluetooth*. The tables below describe the modes you can set for the printer to control the dual interfaces.
- **Automatic selection:**
When the USB cable is connected with a host PC, the USB interface is preferentially selected. Otherwise, the wireless LAN/*Bluetooth* interface is selected. Once the interface is selected, the selection is enabled until the power is turned off or the USB cable is disconnected.

For Wi-Fi model

Interface mode	Wireless LAN	Built-in USB
Automatic selection (initial setting)	Available	Available
Fixed to Wireless LAN	Available	Not available
Fixed to built-in USB	Not available	Available

For *Bluetooth* model

Interface mode	Bluetooth	Built-in USB
Automatic selection (initial setting)	Available	Available
Fixed to Bluetooth	Available	Not available
Fixed to built-in USB	Not available	Available

Command execution during offline

When this function is enabled, you can execute commands that are not related to mechanical operation while the printer is off-line.

- Enabled (initial setting)
- Disabled

Automatic paper reduction

- Extra upper space reduction
 - Disabled (initial setting)
 - Enabled
- Extra lower space reduction
 - Disabled (initial setting)
 - Enabled
- Line space reduction rate
 - Not reduced (initial setting)
 - 25%
 - 50%
 - 75%
- Line feed reduction rate
 - Not reduced (initial setting)
 - 25%
 - 50%
 - 75%
- Barcode height reduction rate
 - Not reduced (initial setting)
 - 25%
 - 50%
 - 75%

CAUTION

- Paper reduction is not performed for space dot lines of graphics printing data.
- When reducing barcode height, be sure to check reading a barcode with your barcode reader in advance.

Automatic power off setting

Selectable from 0, 1 to 60 minutes. (initial setting: disabled)

CAUTION

When using the USB interface, the automatic power off function is disabled even if the time is set.

NOTE

- Power off time becomes 0 minutes when it is set to Disable or 20 minutes when it is set to Enable in Software Setting Mode.
- For detailed information, see "[Auto-Power Off](#)" on page 22.

Battery charge mode

- Mode 1 (initial setting)
- Mode 2

NOTE

For detailed information about the battery charge mode, see "[Battery Charge Modes](#)" on page 22.

Operation mode when battery is low

- Mode 1 (initial setting)
- Mode 2

NOTE

For detailed information about the operation mode when battery is low, see "[Operation Mode When Battery is Low](#)" on page 23.

USB power-saving function

- Enabled (initial setting)
- Disabled

Transmission of Status notice

- Transmits (initial setting)
- Does not transmit

Buzzer settings

- Buzzer sounds for low battery warning
 - Disabled
 - Enabled (initial setting)
- Buzzer sounds for roll paper end warning
 - Disabled
 - Enabled (initial setting)
- Buzzer sounds for error occurrence warnings
 - Disabled
 - Enabled (initial setting)

Error signal output

- Enabled (initial setting)
- Disabled

Paper position immediately after the specific state

Specific state: after the roll paper cover is closed, the printer is reset, or the power is turned on.

- Function Select
 - Enabled
 - Disabled (initial setting)
- Position Select
 - Cut Position
 - Top Position (initial setting)

Communication conditions using a USB interface

- Printer Class
- Vendor Class (initial setting)

Communication conditions using a Bluetooth interface

- Passkey (initial setting: 0000)
- Device name (initial setting: TM-P20_XXXXXX)
- Security (initial setting: Low)
- Auto Re-Connect with iOS device (initial setting: Enabled)

NOTE

The device name is initially set to TM-P20_XXXXXX.
(XXXXXX refers to the last 6 digits of the serial number labeled on the back of your printer.)

Acceptable Characters

Item	Number of characters	Acceptable Characters
Passkey	4 to 16	30H to 39H, 41H to 46H (Indicates the number from "0" to "9" and "A" to "F" in hexadecimal)
Device Name	1 to 31	20H, 21H, 23H to 7EH (Character code between 20H and 7EH and except for the double quotation mark (""))

Desktop Mode setting

When constantly using the printer with a single charger, this function can be turned on to increase the printing speed.

- On
- Off (initial setting)

NOTE

Enabled only under the following conditions.

- Epson TM Utility for iOS/Android Ver.3.10.0 or later
- TM-P20 Utility for Windows Ver.1.20 or later
- Firmware version 1.05 ESC/POS or later

Paper Layout Setting

You can make settings for paper type and size in Paper layout setting. Paper type is set to Receipt paper (without black mark) as default.

In case of using the Receipt paper (with black mark), you must select the Receipt paper (with black mark) for paper type.

When the paper layout setting and the actual paper you are using do not match, the following situations may occur.

- When Paper Type Setting is set to Receipt paper (without black mark) and receipt paper (with black mark) is used, the printer detects paper out.
- When Paper Type Setting is set to Receipt paper (with black mark) and receipt paper (without black mark) is used, a paper error occurs.

To make the Paper Layout Setting, there are following options available.

- Setting with the APD
Set the size of the paper that you are using correctly.
- Setting with the OPOS
See the “PTR_DI_SET_PAPERLAYOUT method” of your driver’s Application Development Guide for details to make the settings.
- Setting with the ESC/POS command
See the “FS (L <fn=33>” (Paper layout setting) of ESC/POS Command Reference for details to make the settings.
- Setting with the ePOS-Print SDK
See “addLayout” method in ePOS-Print SDK User's Manual.
- Setting with the ePOS-Print SDK for JavaScript (available only with the Wi-Fi model)
See “addLayout” method in ePOS-Print SDK for JavaScript User's Manual.

NOTE

- For detailed information about the driver, see ["Drivers" on page 71](#).
- For detailed information about downloading the software and manuals, see ["Software and Manuals" on page 70](#).

Settings/Check Mode

As well as print mode, the following modes are also provided for making various printer settings and checking items.

- Self-test mode
- NV graphics information print mode
- Software settings mode
- Radio field intensity check mode (Wi-Fi model only)
- Wireless module setup mode
- Hexadecimal dumping mode
- Dynamic status sheet print mode (Wi-Fi model only)

The self-test mode or hexadecimal dumping mode is selected depending on the operation performed when the power is turned on.

NV graphic information print mode, Software settings mode, Radio field intensity check mode, and the Wireless module setup mode are selected depending on the FEED button operation performed during a self-test.

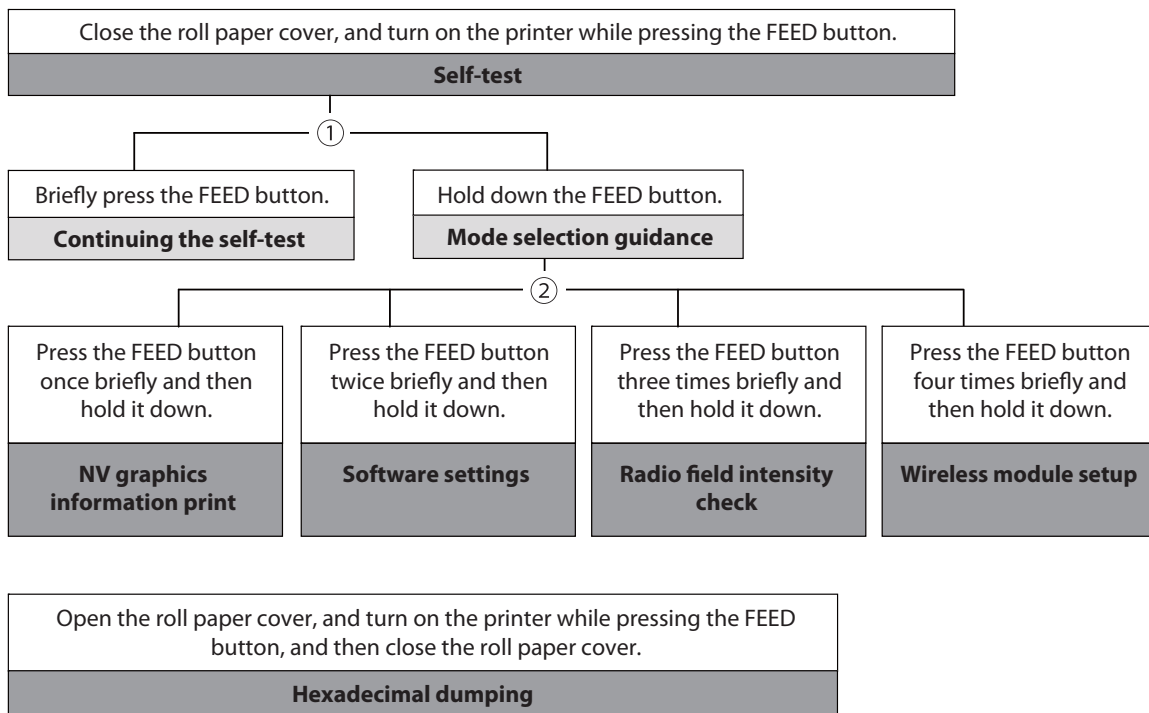

In 1 and 2, the following guidances are printed, the  Power LED flashes, and instructs the user's operations.

1. Continuing self-test guidance

```
Select Modes by pressing Feed Button.
Continue SELF-TEST: Less than 1 second
Mode Selection      : 1 second or more
```

2. Mode selection guidance

```

Mode Selection

Modes
0: Exit and Reboot Printer
1: NV Graphics Information
2: Customize Value Settings
3: Radio Field Intensity Check
4: Wireless Module Setup
5 or more: None

Select Modes by executing following
procedure.
step 1. Press the Feed button less
        than 1 second as many times
        as the selected mode number.
step 2. Press Feed button for 1
        second or more.
```

Self-test mode

You can check the following items using the self-test.

- Firmware version
- Interface information
- Loaded font
- Maintenance information (head mileage)

Follow the steps below.

- 1 Close the roll paper cover.**
- 2 While pressing the FEED button, turn on the printer. (Hold down the FEED button until printing starts.)**
After printing the current print status, a Continuing self-test guidance is printed, and the  Power LED flashes.
- 3 Briefly press the FEED button (less than one second) to continue the self-test.**
The printer prints a rolling pattern on the roll paper, using the built-in character set.
After "****" completed "****" is printed, the printer initializes and switches to standard mode.

NV graphics information print mode

Prints the following NV graphic information registered to the printers.

- NV graphics capacity
- NV graphics usage capacity
- NV graphics free capacity
- NV graphics registration
- Key code for each data, number of X direction dots, number of Y direction dots
- NV graphics data

NOTE

For details on NV graphics, see ["NV Graphics Memory" on page 28](#).

Follow the steps below.

1 After running a self test, hold down the FEED button for at least one second, and then select the Mode selection.

The Mode selection guidance is printed, and the  Power LED flashes.

2 After briefly (less than one second) pressing the FEED button once, hold it down for at least one second, to print the NV graphics information.

After information printing, the Mode selection guidance is printed again.

3 To finish, turn off the power, or select "Exit and Reboot Printer".

Software settings mode

Set the printer's memory switch (customized value).

- Print density
- Automatic paper reduction
- Interface selection
- USB communications settings
- Print speed
- NV memory capacity
- Command execution during offline
- Transmission of status notice
- Buzzer control
- Automatic power off setting
- Paper position immediately after specific state
- Desktop Mode

NOTE

For details on the memory switch (customized value), see ["Software Settings" on page 47](#).

Follow the steps below.

1 After running a self test, hold down the FEED button for at least one second, and then select the Mode selection.

The Mode selection guidance is printed, and the  Power LED flashes.

2 Briefly press the FEED button twice (less than one second), hold it down for at least one second, and then select the Software settings mode (Customized value setting).

The Software setting mode guidance is printed, and the  Power LED flashes.

```

                                Customize Value Settings

Modes
0: Exit
1: Print Current Settings
2: Print Density
3: Automatic Paper Reduction
4: Interface Selection
5: USB Interface Settings
6: Printing Speed
7: NV Capacity
8: Command Execution (Offline)
9: Transmission of status information
10: Buzzer sounds
11: Auto power off
12: Paper Position at Power On
13: Desktop Mode

Select Modes by executing following
procedure.
Step 1. Press the Feed button less
        than 1 second as many times
        as the selected mode number.
Step 2. Press Feed button for 1
        second or more.
  
```

3 After briefly pressing the FEED button (less than one second) for the number of times shown in the print result, hold down the button for more than one second, and then select the setting items.

The setting selected as the setting item, the current settings and initial settings are printed.

Depending on the setting item, you may need to continue selecting the setting item before the settings are printed.

For details on setting items, see ["Software Settings" on page 47](#).

4 Select a setting by briefly pressing the FEED button (less than one second) for the number of times applicable to the setting, and then hold down the button for more than one second to confirm your selection.

After saving the settings, the Software setting mode guidance is printed, and the  Power LED flashes.

5 To close Software setting mode, turn off the printer, or select "Exit" to return to Mode selection guidance, and then select "Exit and Reboot Printer".

NOTE

- To select 0 as the item number, hold down the FEED button until printing starts.
- If the button is pressed a number of times that is not displayed by the Setup guidance, the operation is invalid and the same guidance is printed.

Radio field intensity check mode

Information on the strength of the wireless LAN radio field is printed. (Wi-Fi model only)

Follow the steps below.

- 1 After running a self test, hold down the FEED button for at least one second, and then select the Mode selection.**

Prints the Mode selection guidance, and the  Power LED flashes.

- 2 After briefly (less than one second) pressing the FEED button for three times, hold it down for at least one second to select the Radio field intensity check.**

The operation guidance is printed, and the  Power LED flashes.

```
Radio Field Intensity Check

To start radio field intensity check :
  Press the FEED button 1 second or more.

To end mode :
  Press the POWER button 2 second or more.
```

- 3 Press the FEED button (approximately one second) until the buzzer sounds once.**

Continue this operation when repeating the Radio field intensity check.

```
SSID:ENTest

AP 1
MAC Address   XX-XX-XX-XX-XX-XX
Channel      11
WEP           Disable
Signal Level -xxdbm
Noise Level  -xxdbm
```

Print image for radio field intensity information

- 4 Turn the power off to finish.**

Wireless module setup mode

You can change settings or reset the wireless communication settings. For Wi-Fi models, you can change or reset the wireless LAN settings, and for *Bluetooth* models, you can change or reset the *Bluetooth* settings. For USB connections, the settings are not reset.

Follow the steps below.

- 1 After running a self test, hold down the FEED button for at least one second, and then select the Mode selection.**

Prints the Mode selection guidance, and the  Power LED flashes.

- 2 After briefly (less than one second) pressing the FEED button for four times, hold it down for at least one second to select the Wireless module setup mode.**

The operation guidance is printed, and the  Power LED flashes.

Wi-Fi model

```

Wireless Module Setup
Setup items
0: Exit
1: Initialize
2: SimpleAP
  
```

Bluetooth model

```

Wireless Module Setup
Setup items
0: Exit
1: Initialize
2: Bluetooth
  
```

- 3 Perform one of the following operations according to the printed operation guidance.**

Initialize

1: Select Initialize to initialize the wireless communication settings (network parameters). The printer is reset and restarted.

<Procedure>

After briefly (less than one second) pressing the FEED button once, hold it down until the following message is printed.

```

Initialization was selected.
Please release the Feed button.
  
```

SimpleAP mode (SimpleAP)

In Wi-Fi model, select 2: SimpleAP to start in SimpleAP mode (the same as the factory default setting).
Select this to use Quick connection for Wi-Fi model.

NOTE

For information on the Quick connection function, see ["Useful Functions for Smart Devices" on page 30](#).

Auto re-connect to iOS device (Bluetooth)

In *Bluetooth* model, select 2: Bluetooth and set in 1: Auto Re-Connect iOS, you can select whether to enable or disable auto reconnection to iOS devices.

NOTE

For details on the auto re-connect function, see ["Auto Reconnect Feature" on page 96](#).

Bluetooth Security Settings (Bluetooth)

When the firmware version is 1.01 ESC/POS or later, you can change the *Bluetooth* security settings.

CAUTION

When the security settings are changed, the link key (pairing information) is removed.

NOTE

You can change the settings for TM-P20 Utility and TM Utility for iOS/Android.

For *Bluetooth* models, select 2: Bluetooth, and then select 2: Security, and you can change the *Bluetooth* security settings.

Security	Pairing Mode	Pairing Method
Low	Pairing is always possible	Just Works
Middle	Pairing is possible for one minute after printing the status sheet	Just Works
High	Pairing is possible for one minute after printing the status sheet	Numeric Comparison/Passkey Entry

* When Middle is selected, the power LED flashes in the following pattern while pairing is possible.

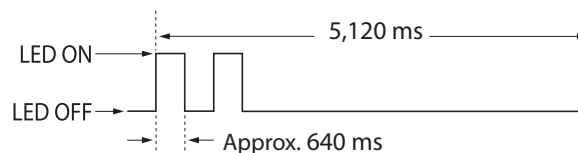

Pairing method when the security is set to Middle/High (from the printer)

When the security is set to Middle/High and the printer is ready to be paired, perform the following procedure.

1 Load paper in the printer, and then turn it on.

CAUTION

Make sure no errors have occurred and that the printer is not off-line.

2 Open the roll paper cover, hold down the FEED button (two seconds), and when the buzzer sounds, close the roll paper cover.

3 A status sheet is printed, and the power LED flashes a pattern indicating that pairing is now possible.

NOTE

Pairing is possible for one minute after printing the status sheet.

Pairing method when the security is set to High (from the host)

When the security is set to High and the printer is ready to be paired, perform the following procedure.

1 Search for the printer on the Bluetooth settings screen on the host device.

2 Select the printer you want to pair with.

The printer prints the Passkey.

3 Check that the printed Passkey and the Passkey displayed on the host device match, and then select "Pairing" on the host device.

Hexadecimal dumping mode

In hexadecimal dumping mode, data from the host computer is printed in hexadecimal numbers and characters. By comparing the print outs and the program, you can check whether or not data is being sent to the printer correctly.

NOTE

- When there are no characters that correspond to the print data, "." is printed.
- If you press the FEED button when there is less than one line of print data, one line is printed.
- During hexadecimal dumping mode, applications that check the printer status may not operate correctly. The printer only returns the status for the "Real-time transmission status" command.

Follow the steps below.

- 1** Open the roll paper cover.
- 2** While pressing the FEED button, turn on the printer. (Hold down the FEED button until the Error LED turns on.)
- 3** Close the roll paper cover.
From this point, all data received by the printer is printed in the corresponding hexadecimal numbers and ASCII characters.

Example of printing in hexadecimal dumping mode

```
Hexadecimal Dump
To terminate hexadecimal dump,
press Feed button three times.

1B 21 00 1B 26 02 40 40 1B 69 . ! . . & . @ @ . i
1B 25 01 1B 63 34 00 1B 30 31 . % . . c 4 . . 0 1
41 42 43 44 45 46 47 48 49 4A A B C D E F G H I J

*** completed ***
```

- 4** To close hexadecimal dumping mode, turn off the printer after printing is complete, or press the FEED button for three times.

Dynamic Status Sheet Print Mode

Wi-Fi Model

In the dynamic status sheet print mode, the printer prints the dynamic status sheet indicating the wireless LAN settings.

CAUTION

Do not run this mode while communicating with the wireless LAN interface. Otherwise, printing might not be performed normally.

NOTE

- Dynamic status sheet cannot be printed in SimpleAP mode (factory default status).
- Dynamic status sheet cannot be printed when USB cable is connected.
- QR code is printed when the firmware version is 1.01 ESC/POS or later.

Follow the steps below.

- 1 **Make sure the printer is turned on.**
- 2 **Open the roll paper cover.**
- 3 **Install the roll paper.**
- 4 **With the roll paper cover open, keep pressing the Feed button until the buzzer sounds.**
- 5 **Close the roll paper cover.**
The printer starts printing the dynamic status sheet.
- 6 **Confirm that “Link Status” value is “Connect” and that “TCP/IP Status” is properly set.**

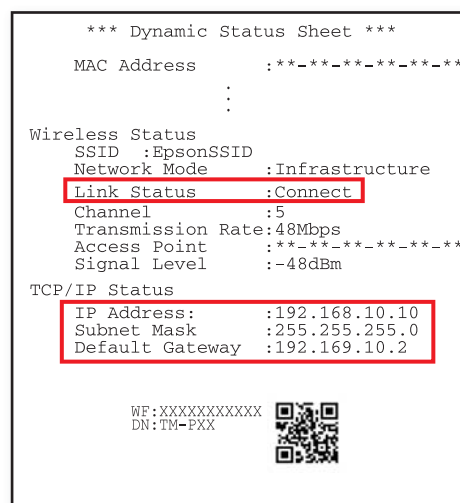

After printing, the printer returns to the normal mode.

Bluetooth Model

In the dynamic status sheet print mode, the printer prints the dynamic status sheet indicating the *Bluetooth* settings.

NOTE

When the firmware version is 1.01 ESC/POS or later, you can print the status sheet.

- 1 Make sure the printer is turned on.**
- 2 Open the roll paper cover.**
- 3 Install the roll paper.**
- 4 With the roll paper cover open, keep pressing the Feed button until the buzzer sounds.**
- 5 Close the roll paper cover.**
The printer starts printing the status sheet.

```
Bluetooth Interface
BD_ADDR      :00:03:7A:0C:B0:82
Passkey      :XXXX
Device Name  :123456878901234567890123456
Module Ver   :12345687890
Module Info  :123456878901
Mode         :Auto re-connect disable
Security     :Low
```

BT:00037A0CB082
DN:TM-PXX



After printing, the printer returns to the normal mode.

EpsonNet Config (Web Version)

EpsonNet Config (Web version) is a utility to configure the network and other settings on a web browser.

Starting EpsonNet Config (Web Version)

Follow the steps below to start up EpsonNet Config (web version).

- 1 Start up a PC connected to the network.
- 2 Start up the web browser and input the printer's IP address (<http://printer's IP address>) in the address bar as shown below.

<http://xxx.xxx.xxx.xxx>

NOTE

- You can check the printer's IP address from the dynamic status sheet or in self-test mode. For details on printing the dynamic status sheet, see "[Dynamic Status Sheet Print Mode](#)" on page 63. For details on the self-test mode, see "[Self-test mode](#)" on page 55.
- In the initial setting, the user name and password will be required on the authentication screen when you access EpsonNet Config (web version) from a browser. Enter "epson" for both user name and password. You can change the password in [Password] in the Optional configuration menu.

EpsonNet Config starts.

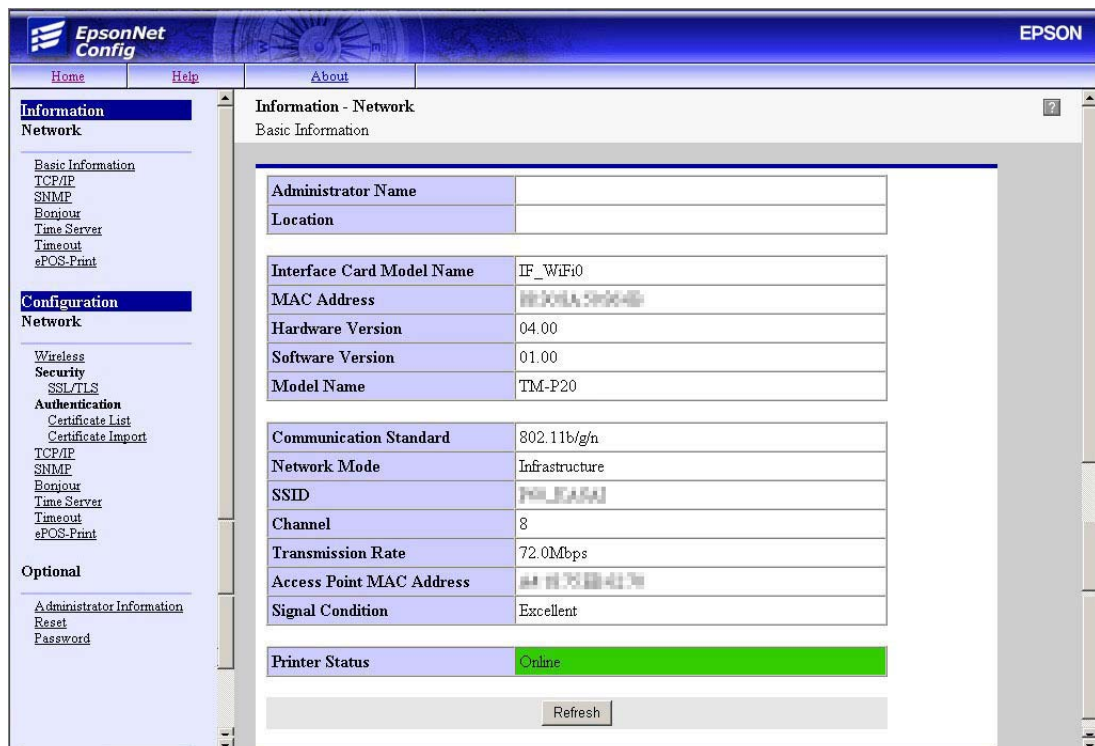

Settings

Select from the menu list on the left to check or configure the settings.

CAUTION

Enable the time server when using a certificate. Otherwise, the printer's Stored Date/Time may not be set correctly and the wireless LAN may be unavailable. If this happens, enable the time server, or initialize the Stored Date/Time from one of the following:

- EpsonNet Config
- EpsonNet Config (Web Version)
- Wireless module setup mode

You can check the printer's Stored Date/Time from the dynamic status sheet.

Information menu

You can check the settings as shown in the table below.

Menu		Settings
Basic Information		Administrator Name, Location, interface Card Model Name, MAC Address, Hardware Version, Software Version, Model Name, Communication Standard, Network Mode, SSID, Channel, Transmission Rate, Access Point MAC Address, Signal Condition, Printer Status
TCP/IP	IPv4 Address	IP Address Settings (Acquiring the IP Address, IP Address, Subnet Mask, Default Gateway) Set Using Automatic Private IP Addressing (APIPA)
	DNS/DDNS	DNS Server Addresses (IPv4) Settings (Acquire DNS Server Address Automatically, DNS Server Addresses) Domain Name Setting (Acquire Domain Name Automatically, Fully Qualified Domain Name, Register the Network Interface's Address to DNS Server)
SNMP		Community (Read Only, Wellknown Community Name) IP Trap (Trap1/2, Address, Community)
Bonjour		Bonjour (Disable/Enable) Bonjour Name, Bonjour Printer Name, Location
Time Setting		Use Time Server Time Server Address, Update Interval, Time Server Status
Timeout		Print (LPR, RAW (Port9100))
ePOS-Print		Version, ePOS-Print (Disable/Enable), Device ID

Configuration menu

You can configure the settings as shown in the table below.

Menu		Settings
Wireless		Wireless Settings (Communication Standard, Network Mode, SSID, Channel, Encryption Type) WPA Pre-Shared Key, Default WEP Key, WEP Key 1/2/3/4, Authentication Algorithm Power Save Roaming AP Density Note: Characters you can use for the User ID/Password when using WPA-Enterprise are as follows: - Character code: ASCII character (20H to 7EH) - Maximum number of characters: 128
Security	SSL/TLS	Server Certificate, Encryption Strength, Automatic Redirect HTTP to HTTPS
Authentication	Certificate List	Self-Signed Certificate (Status, Subject) CA-Signed Certificate 1~3 (Status, Subject) CA Certificate 1~10 (Status, Subject)
	Certificate Import	Certificate Import (File Type, File Name, Password) Note: Characters you can use for the Password section are as follows: - Character code: ASCII character (20H to 7EH) - Maximum number of characters: 64
TCP/IP	IPv4 Address	IP Address Settings (Acquiring the IP Address, IP Address, Subnet Mask, Default Gateway) Set Using Automatic Private IP Addressing (APIPA)
	DNS/DDNS	DNS Server Addresses (IPv4) Settings (Acquire DNS Server Address Automatically, DNS Server Addresses) Host Name and Domain Name Setting (Acquire Host Name and Domain Name Automatically, Host Name, Domain Name, Register the Network Interface's Address to DNS Server)
SNMP		Community (Read/Write, Wellknown Community Name) IP Trap (Trap1/2, Address, Community)
Bonjour		Bonjour (Disable/Enable) Bonjour Name, Bonjour Printer Name, Location
Time Setting		Use Time Server Time Server Address, Update Interval
Timeout		Print (LPR, RAW (Port9100))
ePOS-Print		Version, ePOS-Print (Disable/Enable), Device ID

NOTE

- [Roaming] and [AP Density] in the [Wireless] menu can be set only when the Wi-Fi model's firmware is version 1.17 or later.
- [Wellknown Community Name] in the [SNMP] menu can be set only when the Wi-Fi model's firmware is version 1.19 or later.
The initial value is enabled.
If you disable this setting, there are the following restrictions.
 - * **TM drivers**
The battery status cannot be acquired.
Port opening is extended by approximately 2 seconds.
 - * **Deployment Tool**
The model name cannot be acquired.
 - * **EpsonNet Config/Monitoring Tool**
The model name, status, and setting information cannot be acquired.
The setting cannot be changed.
- You can also select the following functions from the optional configuration menu.
 - * **Administrator Information:** Use to register administrator name and the printer location.
 - * **Reset:** Use to reset the interface card or restore the default settings.
 - * **Password:** Use to change the password.

3 After adjusting the parameters according to the menus, click the [Send] button to send the changes to the printer.

4 On the Web page displayed after you send the changes, click the [Reset] button to confirm that the changes have been applied.

When the IP address, SSID, and so on are changed, you need to change the settings on the host PC and the access point so that they match the printer settings.

Certificate Import

CAUTION

Enable the time server when using a certificate.

Make the following settings in the Authentication - Certificate Import menu.

- 1** Set the file type of certificate.
- 2** Specify the certificate file to import.
- 3** If the file type of certificate is PKCS#12, enter the password.
- 4** Click [Import].

Application Development Information

This chapter describes how to control the printer and gives information useful for printer application development.

Controlling the Printer

The printer supports the following command systems:

- ePOS-Print XML (Wi-Fi model only)
- ESC/POS

Users can control the printer by using the aforementioned commands, or the following development kits or drivers.

- ePOS-Print SDK
- OPOS ADK
- OPOS ADK for .NET
- JavaPOS ADK
- EPSON Advanced Printer Driver (APD)

ePOS-Print XML

ePOS-Print XML is the Epson original control command system for POS printers defined in XML. With ePOS-Print XML commands, you can print in environments where http communication is available and from OS applications.

For detailed information about ePOS-Print XML, see the ePOS-Print XML User's Manual.

On this printer, ePOS-Print XML is only supported by a Wi-Fi model.

CAUTION

To use ePOS-Print XML or SDK for JavaScript, set ePOS-Print to Enable in EpsonNet Config (Web Version) beforehand.

For details about EpsonNet Config (Web Version), see "[EpsonNet Config \(Web Version\)](#)" on page 65.

ESC/POS

ESC/POS is the Epson original printer command system for POS printers and customer display. With ESC/POS commands, you can directly control all the TM-P20 printer functions, but detailed knowledge of printer specifications or combination of commands is required, compared to using drivers and applications.

For detailed information about ESC/POS commands, see the ESC/POS Command Reference.

Software and Manuals

The following software and manuals are provided for application development.

Development Kits

Software	Description	Target model
ePOS-Print SDK	This development kit is for controlling the printer from Web applications and native applications of smart devices. It includes libraries, manuals, and sample programs.	
for iOS		Bluetooth model, Wi-Fi model
for Android		Bluetooth model, Wi-Fi model
for Windows Store Apps		Bluetooth model, Wi-Fi model
for JavaScript		Wi-Fi model only
EPSON OPOS ADK	This OCX driver can control POS peripherals using OLE technology.* ¹ Because controlling POS peripherals with original commands is not required on the application side, efficient system development is possible.	Bluetooth model, Wi-Fi model
EPSON OPOS ADK for .NET	The OPOS ADK for .NET is a POS industry standard printer driver compatible with Microsoft POS for .NET. It allows you to develop applications that are compatible with the UPOS (Unified POS) specification. When developing applications, use a separate development environment such as Microsoft Visual Studio .NET.	Bluetooth model, Wi-Fi model
EPSON JavaPOS ADK	JavaPOS is the standard specification which defines an architecture and device interface (API) to access various POS devices from a Java based system. Using JavaPOS standard API allows control with Javabased applications of functions inherent to each device. A flexible design with Java language and JavaPOS enables many different types of computer systems, such as stand alone or network configuration, to use a same application. You can use JavaPOS to build applications and drivers independently of platforms. This allows flexible configurations using thin clients to meet the system requirements.	Bluetooth model, Wi-Fi model

*1:OLE technology developed by Microsoft divides software into part blocks. The OPOS driver is presupposed to be used with a development environment, such as Visual Basic, unlike ordinary Windows printer drivers. It is not a driver to be used for printing from commercial applications.

You can acquire documents regarding the UnifiedPOS from the following link.

<https://www.omg.org/retail/unified-pos.htm>

Drivers

Software	Description	Operating environment
EPSON Advanced Printer Driver (APD)	In addition to ordinary Windows printer driver functions, this driver has controls specific to POS. The Status API (Epson original DLL) that monitors printer status and sends ESC/POS commands is also attached to this driver.	Windows
EPSON TM Virtual Port Driver	This is a serial/parallel-USB/LAN conversion driver to make an Epson TM/BA/EU printer connected via USB or LAN accessible from a POS application through a virtual serial or parallel port. It allows you to directly control devices connected via USB or LAN with ESC/POS commands without making changes in the POS application that controls devices connected via a serial or parallel interface.	Windows

Utilities

Software	Description	Operating environment
TM-P20 Utility	A utility for checking and changing various printer settings. Use this utility to: <ul style="list-style-type: none"> • Check the current settings • Test operation • Store logos • Set paper saving • Set printing control • Set communication interfaces • Save/restore settings 	Windows
Epson TM Utility	A utility that is available on the App Store or Google Play. Use this to perform wireless connection setup and change settings on the printer from iOS and Android devices. This utility also comes with the following sample printing functions: <ul style="list-style-type: none"> • Sample receipt printing • Customized receipt printing • Printer status display • Quick pairing by NFC/QR code • Easy print by NFC/QR code 	iOS, Android
EpsonNet Config	A network setting tool for Epson network products. In the case of this printer, you can use this tool to check and/or set network parameters by connecting the Wi-Fi model to a computer for setup via the USB interface.	Windows, Mac
TM Bluetooth® Connector	Use to pair a <i>Bluetooth</i> printer and associate the generated <i>Bluetooth</i> port with that used by the driver and applications.	Windows
Deployment Tool	Use to make network and printer settings simultaneously, via USB. Allows you to make settings efficiently at the time of introducing TM printers for the first time, or when configuring multiple TM printers at the same time.	Windows
Monitoring Tool	Use to check a list of status for the Epson printers connected to the network. You can also update certificates for multiple printers used for WPA-Enterprise in a batch.	Windows

Others

Manual	Description
ePOS-Print XML User's Manual	Describes ePOS-Print XML statements. This manual comes with sample programs.
ESC/POS Command Reference	Web contents including detailed description of ESC/POS commands, character code tables, and sample programs. This manual is accessible from the following URL: www.epson-biz.com/pos/reference/

Download

You can obtain software and manuals from one of the following URLs.

For customers in North America, go to the following web site:

www.epson.com/support/

For customers in other countries, go to the following web site:

www.epson-biz.com/

Application Development and Distribution for iOS

If registering an application that uses *Bluetooth* in the App Store, Epson must submit an application to Apple in advance. Please apply for each application you want to register in the App Store from the URL below.

www.epson-biz.com/ais/E/



Handling

This chapter describes basic handling of the printer.

Charging Battery

There are 4 ways to charge the battery:

- using the printer itself with the single charger (OT-SC20)
- using the printer itself with the quad charger (OT-MC20)
- using the battery spacer (OT-BS20) with the single charger (OT-SC20)
- using the battery spacer (OT-BS20) with the quad charger (OT-MC20)



Be sure to use the battery BT-BY20.

Using a battery other than the one specified may cause fire, explosion, leakage, overheating or other damage.

CAUTION

- The battery can be charged only when the temperature is 0 ~ 40°C {32 ~ 104°F}.
- Dispose of used batteries according to the instructions.
- Do not remove the battery during charging.

NOTE

- Fully charging a battery that is fully discharged will take approximately 3 hours.
- Charging the battery at 35°C {95°F} or higher may require a longer charging time than the specified one.
- The Charge LED turns off when charging is not occurring.
- You can use the printer during the battery charging.
- For information on the battery spacer (OT-BS20), see its User's Manual.
- For information on the optional quad charger (OT-MC20), see its User's Manual.

Using the printer itself

- 1 **Connect the single charger or quad charger, AC adapter, and the AC cable as shown in the illustration.**

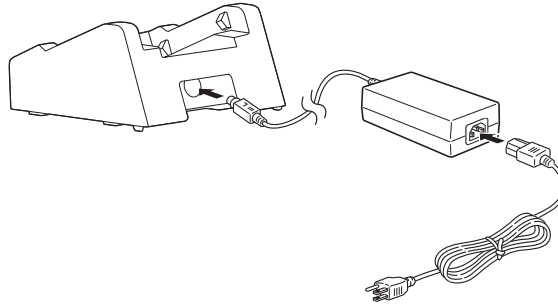

- 2 **Connect the power plug to an electrical outlet.**
- 3 **Connect a printer with a battery installed to the single charger or the quad charger.**
Charging starts. While charging, the Charge LED turns on.
For details on installing a battery in the printer, see ["Installing the Battery" on page 33](#).
- 4 **When charging is complete, the Charge LED turns off.**
- 5 **Press the lever on the single charger or the quad charger, and then remove the printer.**

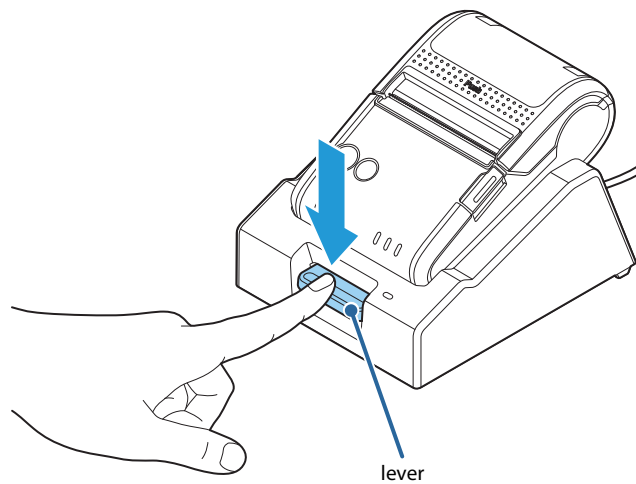

Battery's charging status

Make sure you charge the battery in an environment with a temperature of 0 to 40°C.

Battery charging stops if it is charged in an environment outside the temperature range allowed for charging.

The charging status of the battery is notified by the combination of three LED lights on the Control Panel.



Environment temperature	When the power is ON			When the power is OFF		
	Power LED	Error LED	Charge LED	Power LED	Error LED	Charge LED
50°C and higher						
	Battery high temperature error					
41 to 49°C				Outside the temperature range allowed for charging		
	Outside the temperature range allowed for charging					
0 to 40°C						
	Charging			Charging		
Below 0°C						
	Outside the temperature range allowed for charging			Outside the temperature range allowed for charging		

The Charge LED is located on the single charger (OT-SC20).

NOTE

When the battery is charged in an environment with a temperature of over 35°C, the printer detects an increase in temperature, and automatically stops/resumes the printer; this may extend the charging time.

Battery malfunction

If the battery has been charged for about five hours but cannot be fully charged, it is considered as a malfunction, and Charge LED flashes. If this happens, you cannot use the same battery again. Replace with another battery.



Condition	When the power is ON			When the power is OFF		
	Power LED	Error LED	Charge LED	Power LED	Error LED	Charge LED
Battery malfunction						
Outside the temperature range allowed for charging						

The Charge LED is located on the single charger (OT-SC20).

- * When Charge LED is flashing while the power is off, it indicates one of the two possible conditions: battery malfunction or outside the temperature range allowed for charging. To distinguish battery malfunction, turn the power on, set the roll paper, and check the Error LED and Charge LED while the roll paper cover is closed.

Using the battery spacer (OT-BS20)

- 1** Connect the single charger or quad charger, AC adapter, and the AC cable as shown in the illustration.

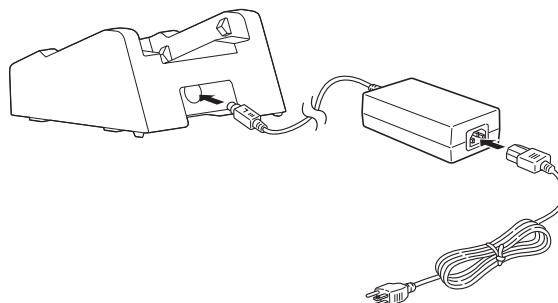

- 2** Connect the power plug to an electrical outlet.
- 3** Connect the battery spacer to the single charger or the quad charger.
- 4** **Set the battery.**
Charging starts. While charging the Charge LED turns on.
If the Charge LED flashes, this indicates a problem with charging. If it continues to flash even after reattaching the battery spacer, the battery or the charger may be malfunctioning.
- 5** When charging is complete, the Charge LED turns off.
- 6** Remove the battery from the battery spacer.

Cleaning the Printer

Cleaning the Printer Case

Be sure to turn off the printer before cleaning. Wipe the dirt off the printer case with a dry cloth or a damp cloth.

CAUTION

Never clean the product with alcohol, benzine, thinner, or other such solvents. Doing so may damage or break the parts made of plastic and rubber.

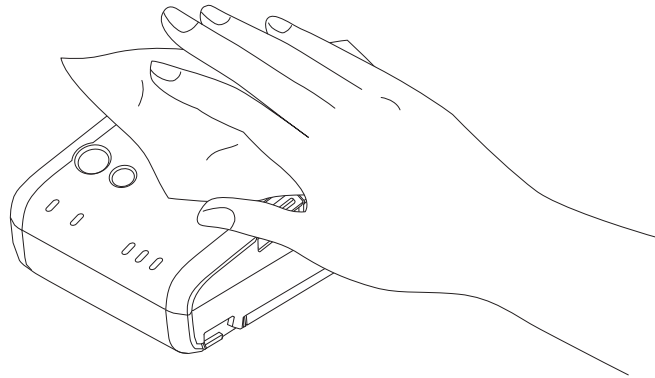

Cleaning the Thermal Head

Epson recommends cleaning the thermal head periodically (generally every 3 months) to maintain print quality.



CAUTION

After printing, the thermal head can be very hot. Be careful not to touch it and to let it cool before you clean it. Do not damage the thermal head by touching it with your fingers or any hard object.

Do not use water. Use an alcohol-based solvent only.

- 1 Turn off the printer, open the roll paper cover.
- 2 Clean the thermal elements of the thermal head with a cotton swab moistened with an alcohol solvent (ethanol or IPA).

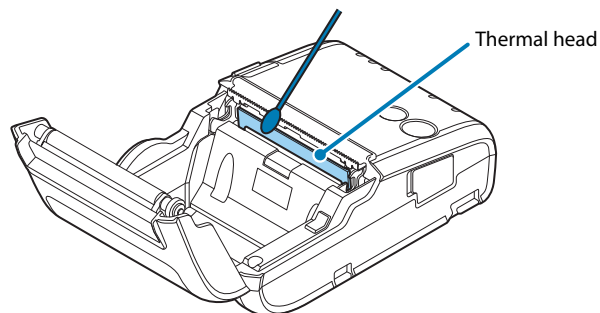

- 3 Close the roll paper cover.

Cleaning the Platen Roller/Paper Sensor

When paper dust accumulates on the platen rollers or the paper sensor, follow the steps below to clean them. To maintain good functional capabilities, clean them regularly (every 6 months).

- 1 Turn off the printer, open the roll paper cover.
- 2 Clean the platen roller and the paper sensor with a cotton swab lightly moistened with water.

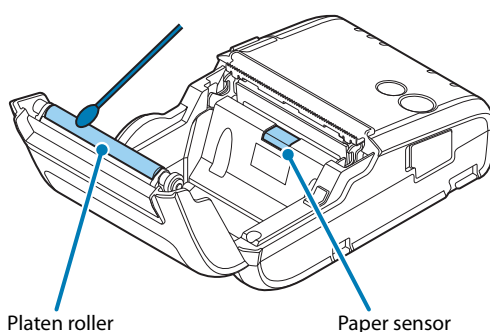

- 3 Close the roll paper cover after the water has dried.

Cleaning the Charge Terminals

Charges may not be performed properly if there is dirt or foreign material on the charge terminals of the printer or single charger. Power off the printer and pull the single charger's AC cable from the outlet. Then, wipe off dirt with a dry cloth or cotton swab. Epson recommends cleaning the parts periodically (generally every 3 months).



- After charging, the charge terminals can be very hot. Be careful not to touch them and to let them cool before you clean them.
- Do not damage the charge terminals by touching them with your fingers or any hard object.
- Do not expose the charge terminals to water. Perform the cleaning using a dry cloth or cotton swab.

<Printer>

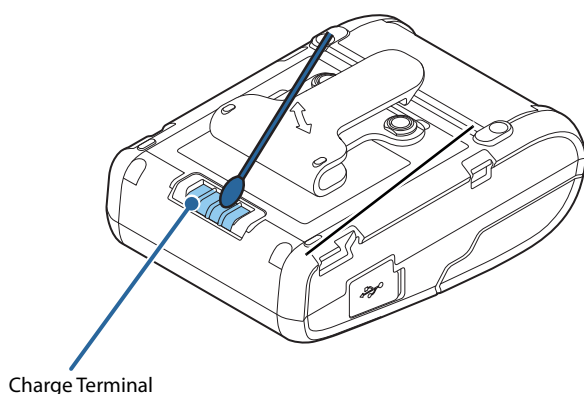

<Single Charger>

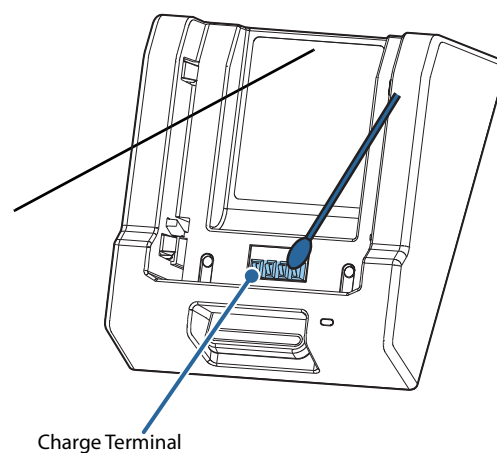



Appendix

Product Specifications

Printing Specifications

Printing method	Thermal line printing	
Dot density	203 × 203 dpi	
Printing direction	Unidirectional with friction feed	
Maximum print speed * ¹	100 mm/s {3.94"/s} (Standard mode) 40 mm/s {1.57"/s} (Fine mode) * ²	
Printing width	48 mm {1.89"}, 384 dots	
Characters per line	Font A	32
	Font B	42
	Font C	42
	Font D	38
	Font E	48
	Kanji Font A	16
	Special Font A	32
	Special Font B	42
Character spacing	0.25 mm {0.01"} (2 dots)	
Paper feed speed	80 mm/s {3.15"/s} (when feeding with the Feed button)	
Line spacing * ³	3.75 mm {0.15"} (2 dots)	

dpi: dots per inch

*¹ The printing speed listed above are the values when using a new battery fully charged, the print density is 100%, and at normal temperature (25°C). The printing speed changes automatically depending on the remaining battery, the head temperature, and the number of print dots.

*² Programmable by commands.

*³ Initial setting. Programmable by commands.

CAUTION

- The maximum printing speed listed above may not be achieved depending on the type of interface, the data transmission speed, and the combination of control commands. Especially, the printing speed may change automatically depending on the communication environment if using a wireless interface.
- If the data transmission speed is slower than the maximum printing speed, or depending on the battery depletion and deterioration conditions and environment temperature, the printing speed may fluctuate, and the print result may become shaded and/or dot displacement in paper feeding may occur.
- If the data transmission speed is slow, intermittent printing may occur and white lines may be formed when printing graphics. To avoid this, keep the print speed constant by setting it lower. The print speed can be set with the customized value. To set the customized value, see "[Software Settings](#)" on page 47.

Character Specifications

Number of characters

ANK models	Alphanumeric characters: 95 Extended graphics: 128 × 43 pages (including user-defined page) International characters: 18 sets
Simplified Chinese models	Alphanumeric characters: 95 Extended graphics: 128 × 43 pages (including user-defined page) International characters: 18 sets Kanji font GB18030-2000: 28,553
Traditional Chinese models	Alphanumeric characters: 95 Extended graphics: 128 × 43 pages (including user-defined page) International characters: 18 sets Kanji font Big5: 13,535
South Asia models	Alphanumeric characters: 95 Extended graphics: 128 × 42 pages (user-defined page is not supported) International characters: 29 sets

Character structure

Common to all models	Font A	12 × 24
	Font B	9 × 24
	Font C	9 × 17
	Font D	10 × 24
	Font E	8 × 16
Chinese model	Kanji Font A	24 × 24

South Asia model	Special Font A	12 × 24
	Special Font B	9 × 24
	Indian Font A	Proportional × 32
	Indian Font B	Proportional × 24

Character size^{*1}

			Standard/Double-height/Double-width/Double-width-Double-height	
W × H	Common to all models	Font A	1.5 × 3.0mm/1.5 × 6.0mm/3.0 × 3.0mm/3.0 × 6.0mm	
		Font B	1.125 × 3.0mm/1.125 × 6.0mm/2.25 × 3.0mm/2.25 × 6.0mm	
		Font C	1.125 × 2.125mm/1.125 × 4.25mm/2.25 × 2.125mm/2.25 × 4.25mm	
		Font D	1.25 × 3.0mm/1.25 × 6.0mm/2.5 × 3.0mm/2.5 × 6.0mm	
		Font E	1.0 × 2.0mm/1.0 × 4.0mm/2.0 × 2.0mm/2.0 × 4.0mm	
	Chinese models	Kanji Font A	3.0 × 3.0mm/3.0 × 6.0mm/6.0 × 3.0mm/6.0 × 6.0mm	
	South Asia models	Special Font A	1.5 × 3.0mm/1.5 × 6.0mm/3.0 × 3.0mm/3.0 × 6.0mm	
		Special Font B	1.125 × 3.0mm/1.125 × 6.0mm/2.25 × 3.0mm/2.25 × 6.0mm	
		Indian Font A	Proportional × 4.0mm/Proportional × 8.0mm/Proportional × 4.0mm/Proportional × 8.0mm	
		Indian Font B	Proportional × 3.0mm/Proportional × 6.0mm/Proportional × 3.0mm/Proportional × 6.0mm	
	CPL	Common to all models	Font A	32/32/16/16
			Font B	42/42/21/21
			Font C	42/42/21/21
			Font D	38/38/19/19
Font E			48/48/24/24	
Chinese models		Kanji Font A	16/16/8/8	
South Asia models		Special Font A	32/32/16/16	
		Special Font B	42/42/21/21	

*1 Space between characters is not included.

cpl: Characters per line

Paper Specifications

Type	Thermal paper: Receipt paper (without black mark) Receipt paper (with black mark)	
Form	Roll paper	
Size	Width	57.5 ± 0.5 mm {2.26 ± 0.02"}
	Outside diameter	40.4 mm {1.59"} maximum
	Roll width when taken up	57.5 ± 0.5 mm {2.26 ± 0.02"}
	Roll paper core	Outside diameter: 18.0 mm {0.71"} or more Width: Same as the paper width or less than the paper width by 1 mm {0.04"}

Specified original paper type

Paper type no.	Manufacturer
P30023, P31023, P35024	Kanzaki Specialty Papers
KT55F20, KT48F20	Koehler
AF50KS-E	Jujo Thermaloy
F5041(48), F5041(55)	Mitsubishi HiTec

CAUTION

- For the winding direction of a thermal roll, the chromogenic side must face outside.
- Paper must not be pasted to the roll paper core.
- For the best print quality for each paper type, it is recommended to set the print density. The print density can be set with the customized value. To set customized value, See "[Software Settings](#)" on [page 47](#).

Requirement for black mark printing

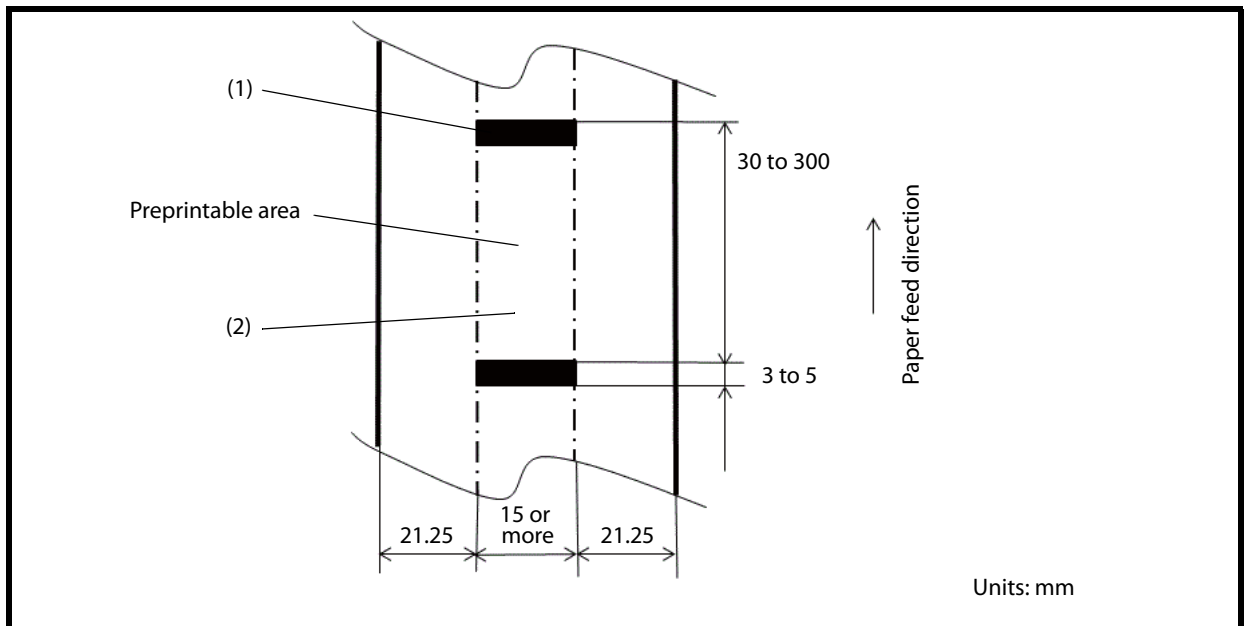

The allowable relation between the reflecting rate in the black mark portion (1) and the non black mark portion (2) must be as shown in the below:

Black mark portion (1): 16% or less

Non black mark portion (2): 85% or more

NOTE

The reflecting rate means the value which is measured with a Macbeth density meter (PCMII) D filter.

Electrical Characteristics

CAUTION

Be sure to install the battery in the printer. The printer does not operate with the single charger only.

Dedicated battery (OT-BY20)*	Model: D171A	Rated voltage: DC 7.2 V Capacity: Typ. 1240 mAh, Min. 1170 mAh
Continuous operating time	Wi-Fi model	Power save mode enabled: Approx. 16 hours Power save mode disabled: Approx. 9 hours
	Bluetooth model	Approx. 26 hours

* Power supply using a single charger (OT-SC20)

NOTE

Above continuous operating times will vary depending on changes in the use environment or condition.

Reliability

Life* ¹	Printer mechanism	10 million lines printing (3.75 mm {0.15"} for one line)
	Thermal head	100 million pulses (for each element), 50 km
	Unit side charging terminal	10,000 times
MTBF (Mean Time Between Failure)* ²		120,000 hours
MCBF (Mean Cycle Between Failure)* ³		16 million lines

*1 End of life is defined as the point at which the printer reaches the beginning of the wear out period.

*2 This is a random failure occurring at the time of the random failure period.

*3 This is an average failure interval based on failures related to wear out and random failures up to the life of 10 million lines.

Environmental Conditions

Temperature and humidity

For operation	When using only battery for power supply (When the battery is not being charged)	Temperature: -10 to 50°C {14 to 122°F} (Bluetooth model) 0 to 50°C {32 to 122°F} (Wi-Fi model) Humidity: 10 to 90% RH (except for paper)
	When using battery and single charger (When the battery is being charged)	Temperature: 0 to 40°C {32 to 104°F} Humidity: 10 to 90% RH (except for paper)

For print quality	When using only battery for power supply	Temperature: 5 to 45°C {41 to 113°F} Humidity: 10 to 90% RH
	When using battery and single charger	Temperature: 5 to 40°C {41 to 104°F} Humidity: 10 to 90% RH
For storage		Temperature: -25 to 70°C {-13 to 158°F} Storage time: 120 hours

Acoustic noise

During operation	Approximately 52.9 dB (ANSI bystander position) Note: Acoustic noise differs depending on the paper used, printing contents, and the setting values, such as print speed or print density.
------------------	--

Drop impact resistance

Height	200 cm (6.6 feet)
--------	-------------------

* The value measurement is equivalent to JIS C60068-2-31:2013 (IEC 60068-2-31:2008) standard.

Dust/splash proof function

Vertical placement	IP4X equivalent Note: Roll paper side is excluded. When roll paper recess is installed on the bottom side. The Connector cover is closed.
Horizontal placement	IP4X equivalent Note: Roll paper side is excluded. When the belt clip is installed on the bottom side. The Connector cover is closed.

* The value measurements are equivalent to JIS C0920 (IEC60529:2001) standard. Therefore, safety standard application, and failure and breakage of the printer are not guaranteed.

External Dimensions and Mass

- Width: Approximately 79 mm {3.11"}
- Depth: Approximately 119.8 mm {4.72"}
- Height: Approximately 43.6 mm {1.72"} (the belt clip excluded)
- Mass:
 - Wi-Fi model: Approximately 221 g {0.49 lb}
 - Bluetooth model: Approximately 212 g {0.47 lb}(Battery included; belt clip and roll paper excluded)

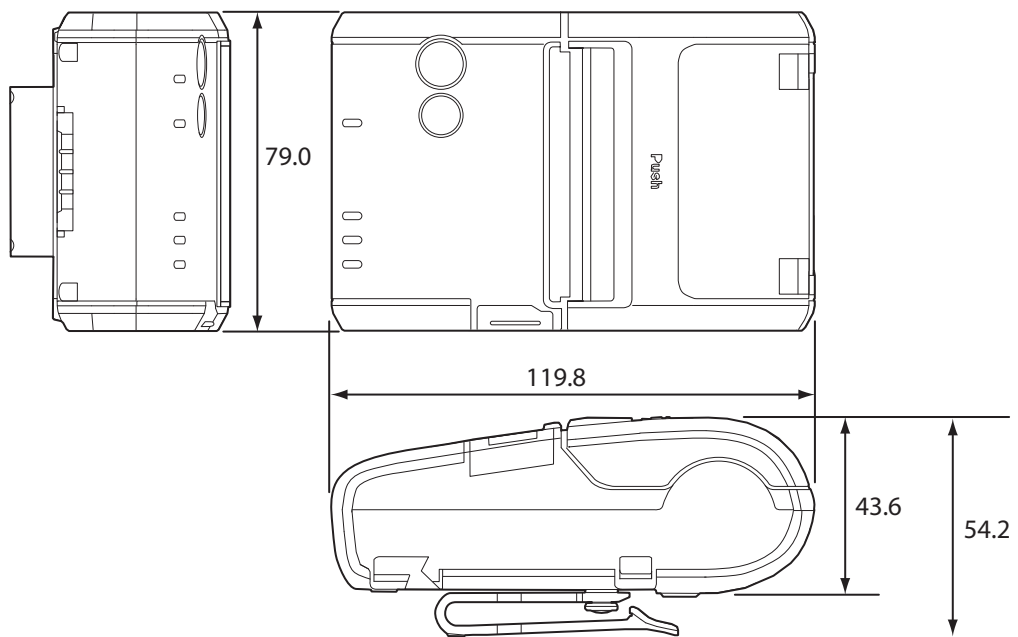

Colors

EBCK (Epson Black)

Specifications of Interfaces and Connectors

USB Interface

USB interface connector

Has a USB connector (mini USB type-B connector)

USB transmission specifications

USB function

Overall specifications	According to USB 2.0 specifications	
Transmission speed	USB Full-Speed (12 Mbps)	
Transmission method	USB bulk transmission method	
Power supply specifications	USB self power supply function	
Current consumed by USB bus	2 mA	
USB packet size (with full-speed connection)	USB bulk OUT (TM)	64 bytes
	USB bulk IN (TM)	64 bytes
USB device class	Both USB vendor-defined class and USB printer class are supported.	

NOTE

To set the USB device class, see ["Software Settings" on page 47](#).

USB descriptor

		USB vendor-defined class	USB printer class
Vendor ID		04B8h	04B8h
Product ID		0202h	0E1Ch
String Descriptor	Manufacturer	EPSON	EPSON
	Product	TM-P20 Wi-Fi TM-P20 Bluetooth	TM-P20 Wi-Fi TM-P20 Bluetooth
	Serial number	Character string based on the product serial number	Character string based on the product serial number

Wireless LAN Interface

CAUTION

Countries where Wireless LAN can be used are limited. Since notes are provided for each country, check the sheet supplied with the product.

Specification

- IEEE802.11a/b/g/n (2.4 GHz band or 5 GHz band) compliant wireless LAN communication compatible
- Infrastructure mode and 802.11 Ad-hoc mode are supported
- Support the IP address automatic acquisition function (DHCP, APIPA).

Communication standard

- IEEE802.11a (5 GHz)
- IEEE802.11b (2.4 GHz)
- IEEE802.11g (2.4 GHz)
- IEEE802.11n (2.4 GHz)
- IEEE802.11n (5 GHz)

Security

Security can be selected from among the following:

- WEP
- WPA
- WPA2-Personal
- WPA2-Enterprise

Initial settings

These settings apply when the printer is initialized in the Wireless module setup mode.

Parameter	Setting value
Communication standard	802.11b/g/n
Network mode	Infrastructure mode
SSID	EPSON_Printer
Encryption type	WPA2-Personal
Passphrase	EpsonNet
IP Address	Automatically acquired by DHCP

* You can connect to a WPA2-PSK (AES) access point using the settings above.

Settings in SimpleAP mode (Factory default settings)

Parameter	Setting value
SSID	EPSON_Printer
Passphrase	12345678
IP Address	192.168.192.168
Subnet mask	255.255.255.0

Printing communication protocol

- LP, LPR: Transfers printing data
- TCP Socket Port: Transfers printing data and printer status via bidirectional direct socket communication.

LP, LPR

- Max. simultaneous connections: 2
- Number of connections for which printing is available: 1 (Other users need to wait until printing is completed.)
- Time out: 1 min. (changeable)
- Job cancel: Not available
- Banner printing: Not available

Socket communication

- Port type: TCP communication port for direct printing
- Port number: 9100
- Port communication direction: bidirectional
- Max. simultaneous connections: 3
- Number of connections for which printing is available: 1 (Other users need to wait until printing is completed.)
- Time out: 5 min. (changeable)

Notes on Using the Wi-Fi Model

- Keep the printer away from the devices, such as kitchen microwaves, that may cause radio wave interference.
- Use channels that are away from the frequency bands that may cause radio wave interference.
- Place shields between the printer and the devices that may cause radio wave interference.
- Select either 2.4 GHz or 5 GHz, whichever is free from radio wave interference.
- In auto channel setting for the access point, do not select a channel in which the printer may cause radio wave interference.

Notes on Wireless LAN connection

Because not all the combinations of the printer and wireless LAN devices have been checked for operation, the operation of the printer in combination with all the wireless LAN devices is not guaranteed. Especially in the ad-hoc mode, the printer may not operate normally, depending on the combination of the device to connect with. Be sure to carry out evaluation of the operation before use.

Notes on use

- When you initialize or change the printer settings, the printer is reset to reflect the settings. It may take about 1 minute depending on the network settings or environment. Also, your application may indicate power off during the time waiting for reset. In that case, wait for about 1 minute, and then reconnect to the printer.
- Where wireless LAN communication is in heavy traffic, your application may falsely recognize that the communication is disconnected and indicate power off due to response delay. In that case, disable Power Save to improve the trouble.

Notes on using the roaming function

When the roaming function is enabled, if you continue to use the printer in an area where the radio waves for the access point that is connected to are weak, the printer will continue to search for an access point with stronger radio waves, thus shortening the battery life.

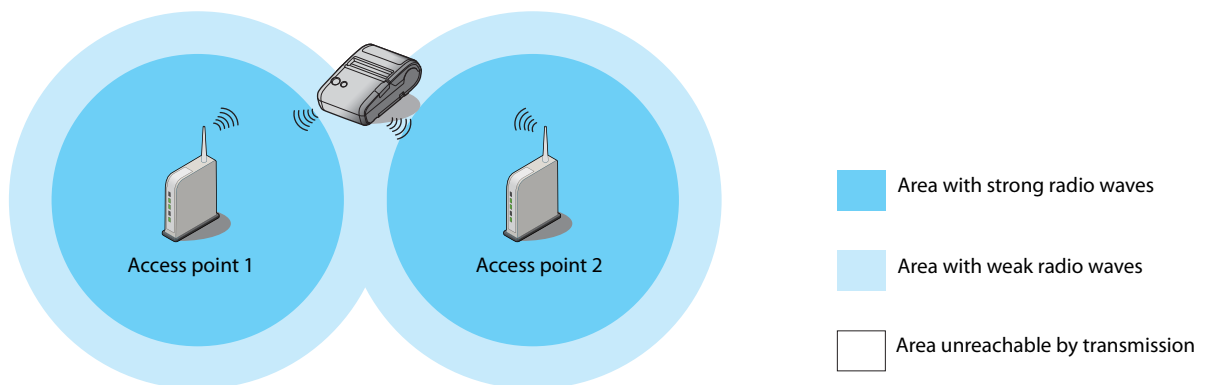

Bluetooth Wireless Interface

CAUTION

Countries where *Bluetooth* can be used are limited. Since notes are provided for each country, check the sheet supplied with the product.

Specification

- *Bluetooth* 3.0 (EDR supported)
- *Bluetooth* Power Class 2
- Built-in antenna
- Pass key setting is possible
- Device name setting is possible

Initial Settings

Setting Contents	Setting Items	Initial Settings
Bluetooth communication settings	Bluetooth passkey	"0000"
	Bluetooth device name	TM-P20 : "TM-P20_XXXXXX" (Where XXXXXX is the last six digits in the serial number)
	Bundle Seed ID	"TXAEAV5RN4"
	Enable/Disable auto reconnect to iOS device	"1" (Enable)
	Bluetooth Security	Low

Auto Reconnect Feature

The auto reconnect feature allows the printer to automatically restore a connection in the following situations if the *Bluetooth* connection to the iOS device is lost.

- When the printer is turned on
- When the signal is dropped and then restored

The following shows the printer operations and connection methods when the auto reconnect feature is enabled or disabled.

Auto Reconnect Feature	Enabled	Disabled
Printer operations when <i>Bluetooth</i> is disconnected	Perform the following reconnection sequence. [Reconnection sequence] 1. The printer tries to connect to the iOS device to which it was last connected. 2. When step 1 fails, the printer waits for connections from other devices. 3. If connection is not established in step 2, the printer tries again to connect to the iOS device to which it last connected. Steps 1 and 2 are repeated until a connection is established.	Wait for a connection from the <i>Bluetooth</i> device.
Reconnecting to iOS device	Reconnect automatically.	Make settings on the <i>Bluetooth</i> settings screen on the iOS device.
Switch to connection from other device	Method 1: After disabling the <i>Bluetooth</i> feature of the connected iOS device, make connection settings on the <i>Bluetooth</i> device that you want to connect. (When the auto reconnect feature is enabled, it may take some time to connect.)	
	Method 2: (Only when the firmware version is 1.01 ESC/POS or later) After disconnecting from the connected iOS device using applications with the TM Utility or ePOS-Print SDK disconnection feature, make settings on the <i>Bluetooth</i> device you want to connect.	

- * In the following situations, even if the feature is enabled, the same operations are performed as when it is disabled.
 - When pairing is canceled from the connected iOS device.
 - When the last *Bluetooth* device connected was not an iOS device.
 - When wireless communication settings are initialized from the printer.
- * Disable this feature when using the printer from devices that are not running iOS. Otherwise, it may take some time to connect.
- * See "[Wireless module setup mode](#)" on page 59 for settings for the auto reconnect feature.

Notes on use

Time required until printing starts

If the host computer and the printer are not connected on a continuous basis but rather connected every time the printer starts printing, some time may be needed for the printer to actually start printing after the host computer commands printing. This pause is the time required for processing the connection between the host computer and the printer.

After opening the port, leave an interval of 300 msec or more before sending data to the port.

Timing to shut the connection off

If a connection between the host computer and the printer is shut off while the printer is offline, it may not be re-established. In this case, first clear the printer offline causes, and then try to re-establish the connection.

Notes when communicating with Android devices

- The printer cannot connect to Android 2.3 and 2.3.2.
- When communicating with Android 2.3.3 or later versions, communicate through an insecure connection.

Notes when communicating with iOS devices

Print data deletion and *Bluetooth* disconnections occur

Situation

Depending on the specifications of the iOS device, print data sent to the printer may be deleted. When this occurs, the *Bluetooth* connection between the printer and the iOS device is disconnected.

Conditions

This occurs when the printer is not ready to print, and 64 KB or more of print data is sent to the printer.

<Status in which the printer cannot print>

- When the roll paper cover is open
- When the paper is out

Solution

Do not send data to the printer if the printer is not ready to print.

For developers using the SDK from Epson, see the User's Manual - Chapter 3 Programming Guide - "Printing After Checking the Printer Status".

Since *Bluetooth* is disconnected when this occurs, if the auto reconnect feature is not enabled, you need to reconnect from the Bluetooth settings screen on the iOS device.

When using the SDK from Epson, this connection process is not necessary.

The iOS application cannot receive the data sent from the printer

Situation

Although the printer sends data to the iOS device and the data is received by the iOS device, depending on the combination of the iOS version and the iOS device, the iOS application may not be able to receive the data.

Conditions

This may occur in combinations of the following conditions.

- iOS version: 7.1, 7.1.1
- iOS device: iPhone 5s, iPhone 5c, iPhone 5, iPad Air, iPad mini with Retina display, iPad (4th generation), iPad mini, iPod touch (5th generation), iPhone 4s, iPhone 4, iPad (3rd generation), iPad 2
- Application processing: If the *Bluetooth* port is closed and then reopened while the application is running.

Solution

The solution differs depending on the iOS device being used. See the following table.

iOS Device	Solution
iPhone 4s iPhone 4 iPad (3rd generation) iPad 2	This situation can be avoided by using the ePOS-Print SDK for iOS which is included in the ePOS-Print SDK Release 14.06.30E or later package.

NFC Tag

Transmission standard	ISO14443 A
Frequency	13.56 MHz
Memory	144 byte
Transmission distance	Approximately 10 mm from the NFC installation location.

NOTE

- The transmission distance is an estimate that depends on our experiment conditions and is not a guaranteed value.
- It varies based on the installation environment and target device.

Character Code Tables

Refer to the following URL regarding the character code table.

www.epson-biz.com/pos/reference/charcode/